

Uplevel Performance, Ensure Protection

Sustainable power solution for hyperscale data centers
with industry leading efficiency



The power behind competitiveness

Delta UPS Ultron Family DPM Gen2 Series

250-1750 kVA (380/400/415 Vac)

300-2100 kVA (480 Vac)

Building Upon Mastery, Forging Ahead

The Delta DPM series, an exceptional 3-phase uninterruptible power supply (UPS), is crafted to meet the evolving needs of future data centers. This series is available in both 3-wire and 4-wire configurations that showcase impressive industry-leading efficiency. With versatile operational modes, including the reliable clean mode and grid interactive function for renewable energy integration, it's designed for seamless adaptability.

DPM has been a sustainable power solution preferred by global cloud giants and leading semiconductor companies since 2015 due to its proven high reliability and efficiency. DPM Gen2 now pushes the limits forward, with industry leading efficiency and more advanced features. Select the ideal fit for your demands from a range of 250 kW to 16 MW.

Explore the new DPM Gen2!

Wide range of industrial applications



Data Centers

- Large & hyperscale data centers
- Cloud and colocation
- Enterprise data centers
- Telecom data centers



Power & Grid

- Solar control
- Wind farm monitoring
- Generator protection
- Thermal plants
- Hydro turbine control

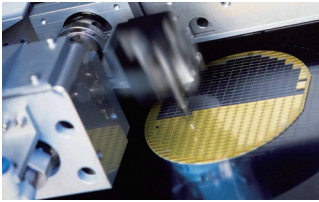

Industrial Processes

- Semiconductor manufacturing
- Precision manufacturing
- Automation production



Healthcare

- MRI, radiology and imaging facilities
- Emergency power systems
- Lab Infrastructure



Transportation

- Signal and communication systems
- Traffic control
- Security
- Lighting

Protects
25%+
of world foundry
output power
backup



Grow at your own pace, embrace redundancy

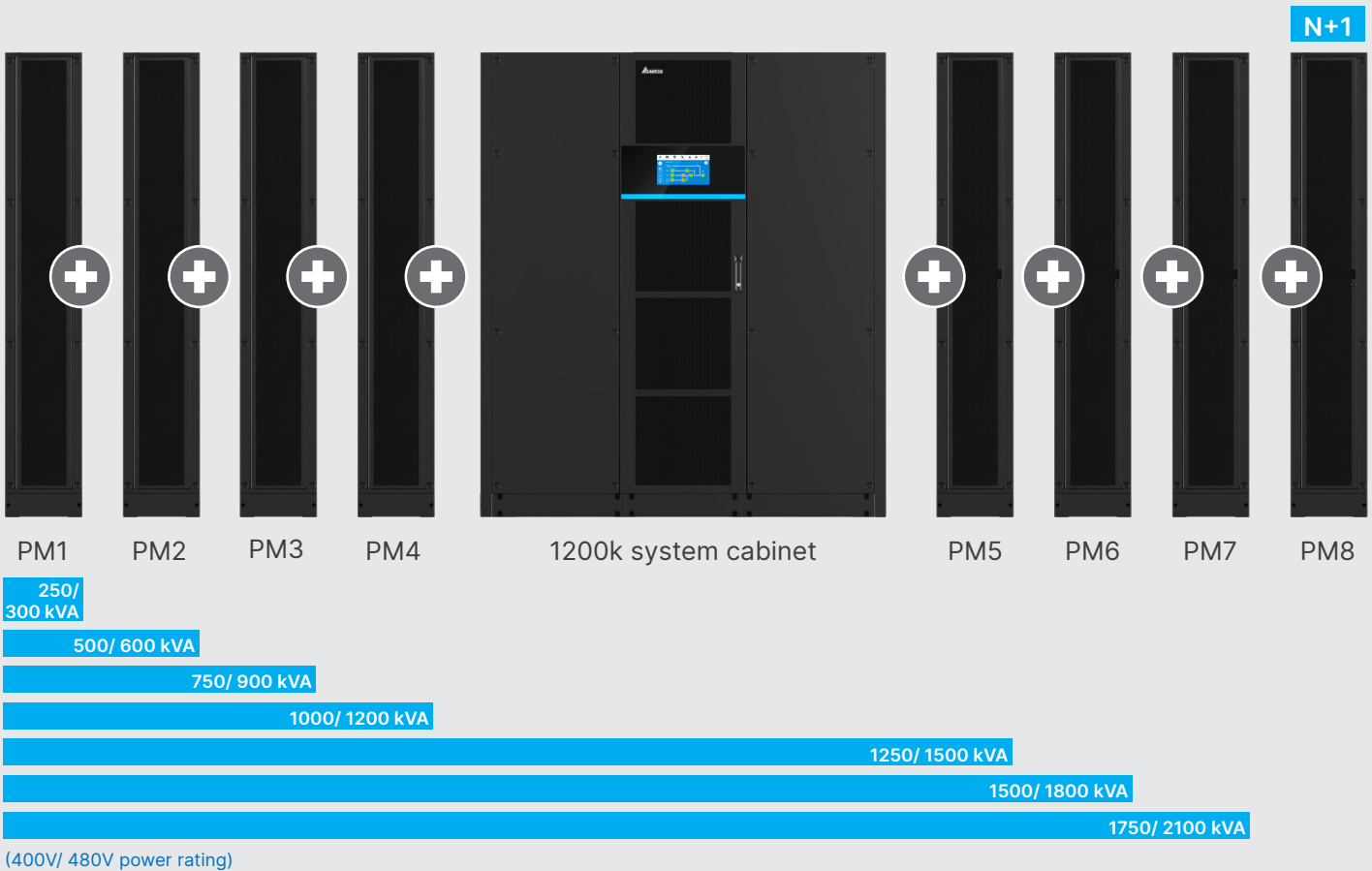

Power modules support N+1 internal redundancy

Enhanced Safeguards, Wider Selection

Power Rating

250-1750 kVA (380/400/415 Vac)

300-2100 kVA (480 Vac)

Sync multiple buses

Parallel up to 8 units



Up to **16 MW** fulfills the power needs of hyperscale data centers

Smart Investments, Big Returns

Leading efficiency, less spend

In a world fueled by data, energy needs are surging while the demand for sustainability grows louder. We are standing at the intersection of limitless computing power and the urgent need to conserve energy.

Meet DPM Gen2 – Delta's unwavering solution that provides a greener data center that harmonizes peerless performance with eco-consciousness.

Industry-leading efficiency

With next-Gen SiC IGBTs, we've slashed switch and core losses to redefine efficiency. The magic continues as we optimize PCBs and craft distinctive heatsinks, reducing inductive coupling, stress, and fan power by a remarkable 80%! What's the result? Industry leading AC-AC efficiency has come true, cutting both electricity and cooling costs!

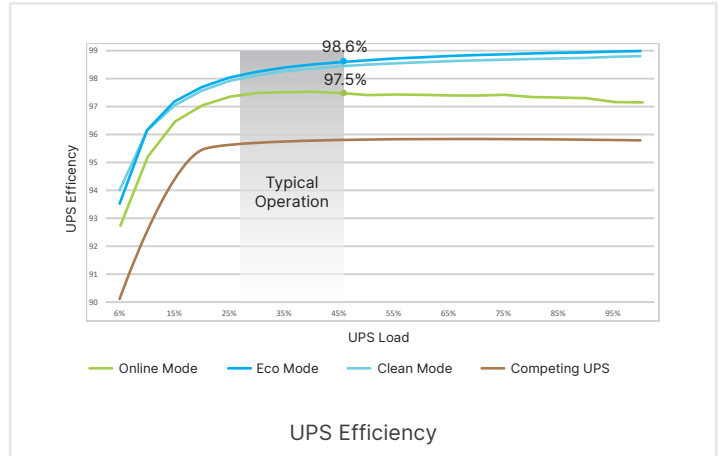

Experience clean mode brilliance

The DPM Gen2 is equipped with a clean mode that functions as an active filter, adeptly compensating for power line disturbances from reactive or non-linear loads, and ensuring optimal performance. Whether correcting power factors, filtering harmonics, or seamlessly transitioning to battery operation, clean mode consistently delivers peak efficiency, making it a reliable choice for power management.

ECO Mode (VFD Mode)

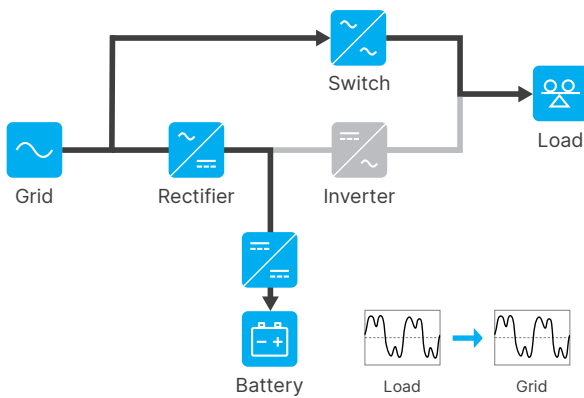

Clean Mode (VI Mode)

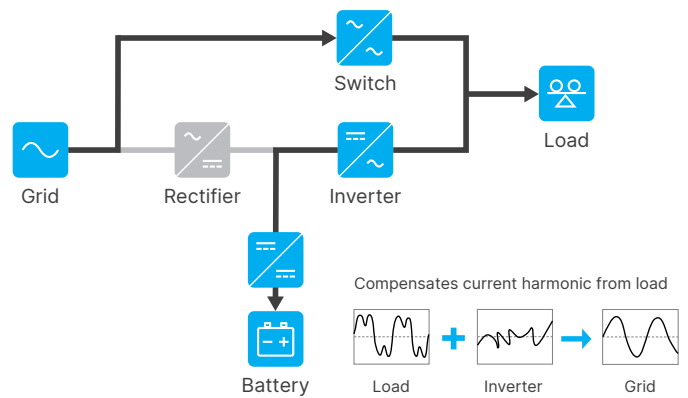

How is clean mode different from Eco mode?

- Reduces current harmonic to source (generator) and load
- Corrects source power factor
- Faster transfer time
- Enhanced fault-clearing strength for load ground faults

What can you gain by using a high efficiency UPS?

- Greater light-load efficiency & energy cost savings
- Lower heat level with less cooling energy spending
- Less stress on each component, longer component lifespan
- Quieter fans
- Reduced carbon emission costs

Savvy Design, Streamlined Cost

Facility lean, savings deep

The establishment of a data center involves not only expenditures on UPS equipment and electricity but also considerations for upfront costs in the frontend, such as generator size, input breaker, and cabling CAPEX. DPM Gen2 thoughtfully addresses these requirements, meeting your expectations for streamlined costs and facility efficiency through outstandingly savvy design.

Streamlining generator sizing

DPM Gen2's exclusive **Advance Power Walk-in** design intelligently fine-tunes power distribution between the generator and battery during a power shift, ensuring a smooth transition. Unlike traditional UPS systems using direct transfer or sequential start methods, DPM Gen2 takes a unique approach. If the generator frequency exceeds its range, DPM Gen2 temporarily halts the transfer, allowing it to return to the correct range. This unique approach maintains optimal generator frequency, eliminating the need for unnecessary expansions.

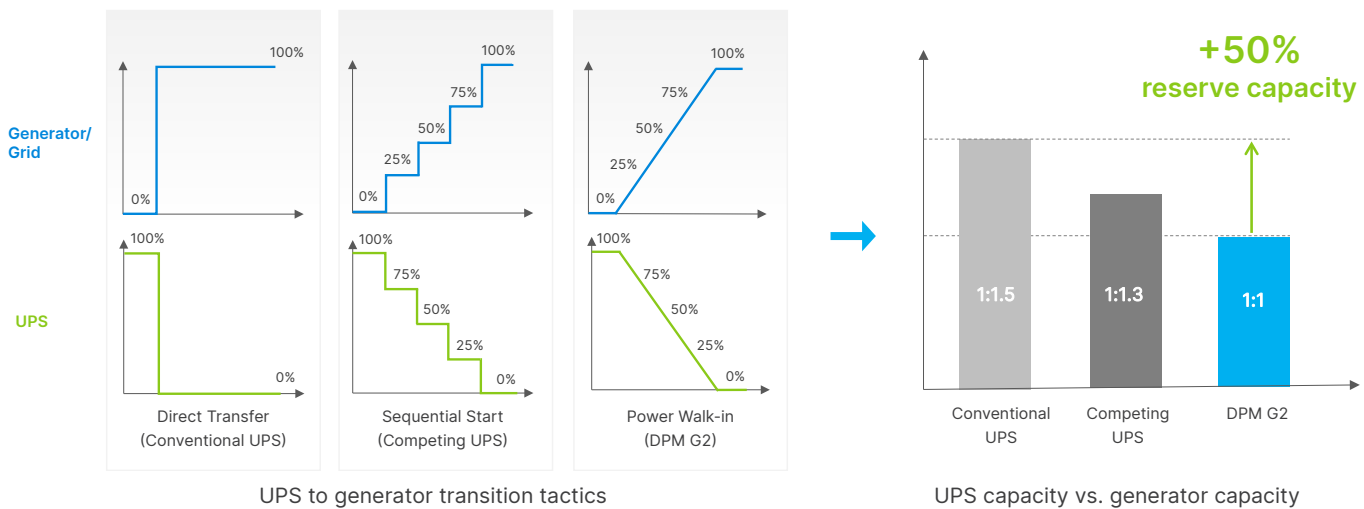

Input current limiting

DPM Gen2 efficiently handles peak input current during low mains by controlling the input through its rectifier and DC-DC converter. In under-hybrid mode, the battery provides partial power support. If the mains frequency drops, signaling insufficient capacity, the UPS takes over. The **Input Current Limiting** function prevents generator damage by managing load fluctuations, eliminating the need for costly breaker upgrades to ensure power quality and optimize backup time!

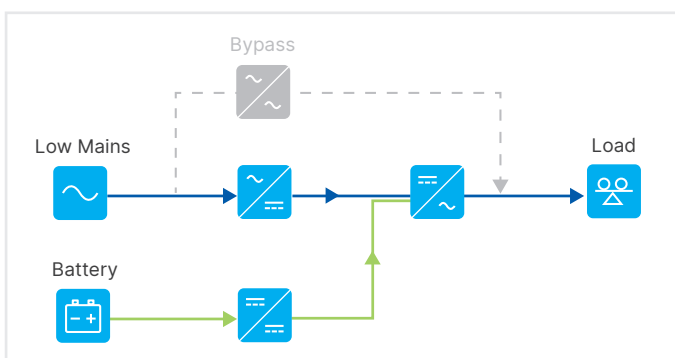

Burn-in test with load bank? Not anymore!

Unlock the power of full-load and full-battery discharge tests, performed on-site during commissioning, system upgrades, or repairs. Bid farewell to load banks and temporary setups, while streamlining your process and cutting costs.

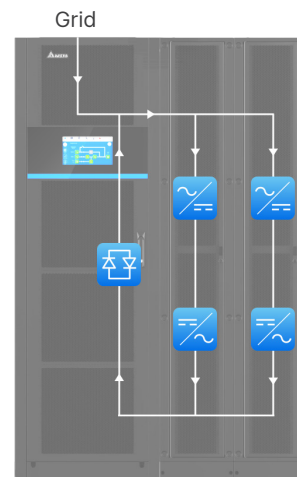

Strategic Engineering, Pinnacle Reliability

Sync. unleashed, operation nonstop

Ultimate system reliability: SMB Inbuilt!

In hyperscale data centers or colocation facilities, ensuring higher system reliability relies on a dual power source with STS, highlighting the vital role of SMB (Synchronized Multiple Bus) functionality. Without synchronization, switching to the 2nd Source may cause phase mismatches, potential issues, inrush currents, and unstable power. DPM's SMB technology ensures smooth source transfer, reduces switching problems, controls inrush currents, enhances system stability, and prevents voltage instabilities, ensuring a reliable and stable power supply.

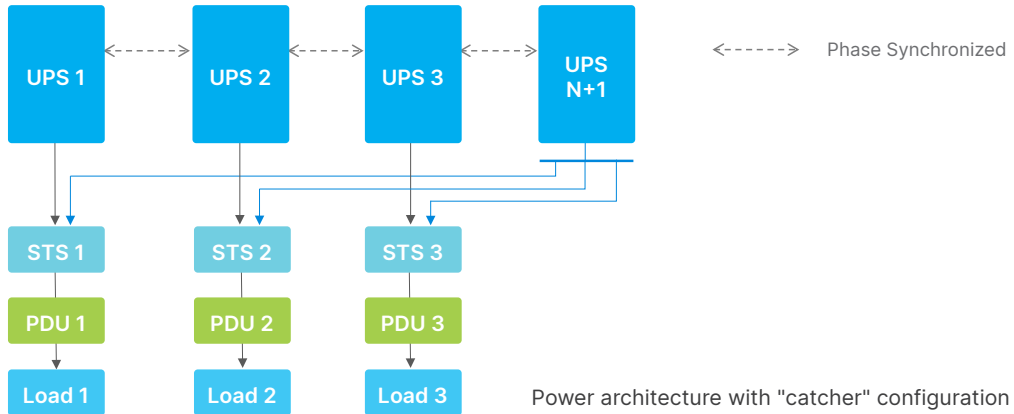

Redundant design for optimized uptime

DPM Gen2 offers robust redundancy at system and modular levels as well as key components, guaranteeing unparalleled uptime. Power module supports N+1 inherent redundancy while system control modules feature redundant controllers and auxiliary power, elevating system availability and eliminating the threat of single point of failure.

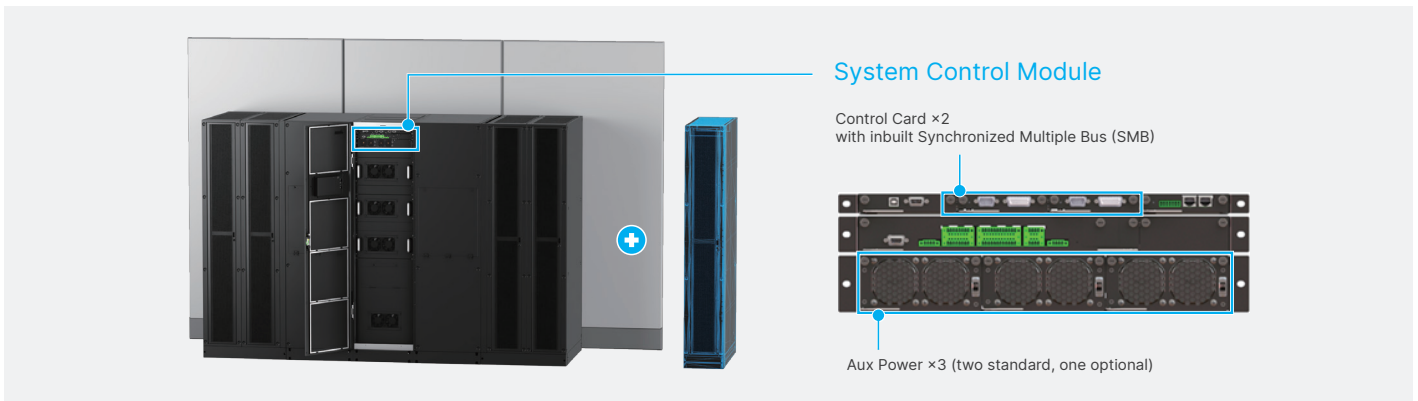

Precision maintenance with AI insight

Equipped with diverse sensors, DPM Gen2 captures critical data from IGBTs, fans, and capacitors. This elevates maintenance accuracy with AI technology, surpassing traditional periodic methods.



Greener Solution, Reaping Rewards

Grid harmony, future-ready

In the age of AI and data centers, the surging global demand for electricity is challenging power plants and prompting stricter regulations for major users. Additionally, as the energy industry undergoes a transformative shift towards renewables and decarbonization, the importance of power backup facilities supporting consistent renewable energy becomes increasingly vital. This consideration is gaining prominence as data centers actively work towards establishing zero-carbon timelines.

Grid resilience and green energy ally

To address grid management challenges comprehensively, DPM Gen2 introduces advanced features such as **Demand Response** and **Frequency Regulation**, stabilizing the grid by charging or discharging on command, ensuring not only grid stability but also a consistent supply of renewable energy.

During unpredictable periods of renewable energy supply, it seamlessly engages in battery-assisted grid power generation, thereby providing data centers with a stable and sustainable power source. This unique functionality positions DPM Gen2 as a reliable solution for both regulatory compliance and the evolving needs of a renewable energy-driven landscape.



Grid demand management

Leveraging the grid interactive capabilities of DPM Gen2, it strategically discharges to circumvent peak-time charges while efficiently shifting energy consumption to cost-effective off-peak hours. This intelligent approach not only enhances grid management but also results in substantial savings on electricity bills.

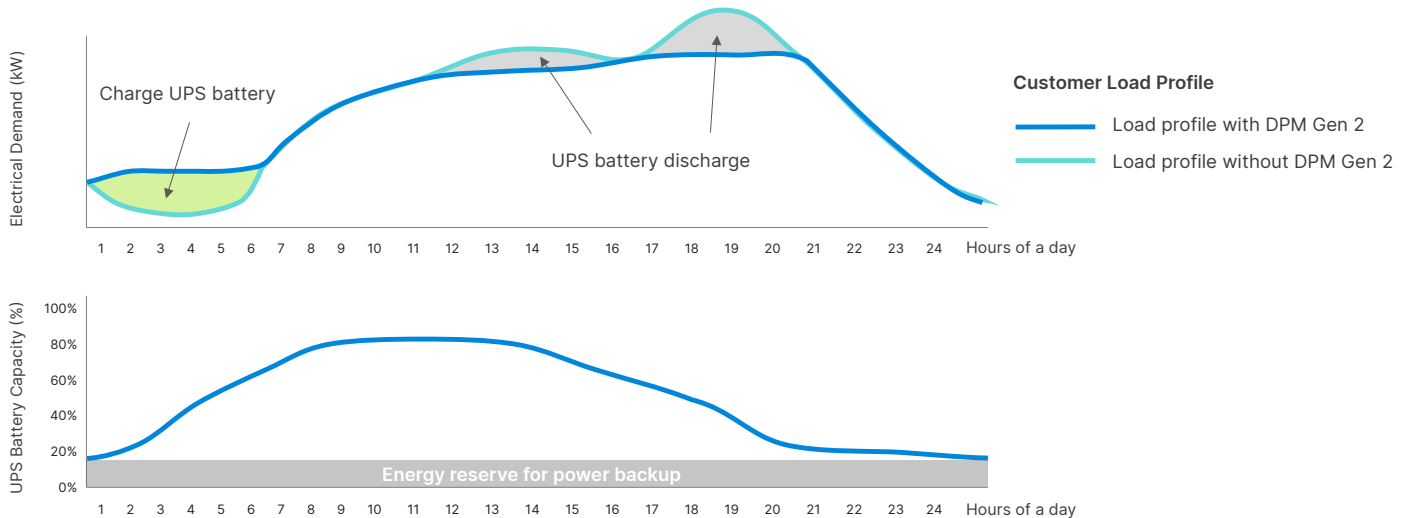

Battery flexibility, lithium-ion battery ready

DPM Gen2 extends its versatility by providing adjustable voltage support for various battery types, including VRLA, Vented lead-acid, Lithium-ion, and Ni-zinc batteries. Make the best choice based on your priorities—budget, space, weight or sustainability. Opt for Delta Lithium-ion batteries for compactness, fast charging, and real-time data on health and performance via the UPS LCD. Enjoy simplicity with Delta's battery management.



Versatile Features, Easy Management

Intuitive controls, simple maintenance

Easy management

Experience the intuitive 10" color touchscreen: Your gateway to real-time data and on-site mastery. Navigate through 5000 event logs effortlessly using the intuitive LCD panel or SNMP card for thorough event tracking.

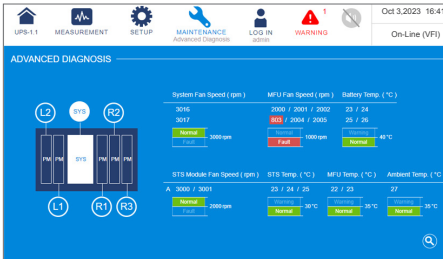

System and power module detection

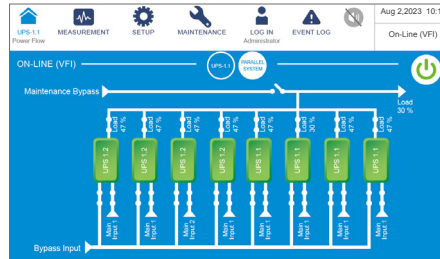

Parallel system view

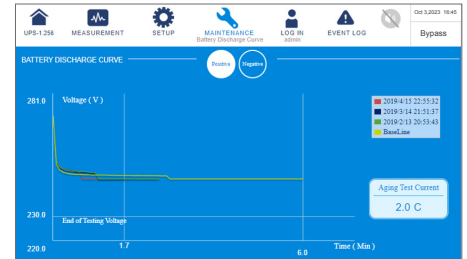

Battery discharging curve

Easy installation

Enjoy a remarkable 25% reduction in footprint and a 35% less weight compared to its predecessor. Embrace seamless against-the-wall installation without compromising performance. Revel in the flexibility of top and bottom cable entry, unlocking unparalleled optimization for your data center space.

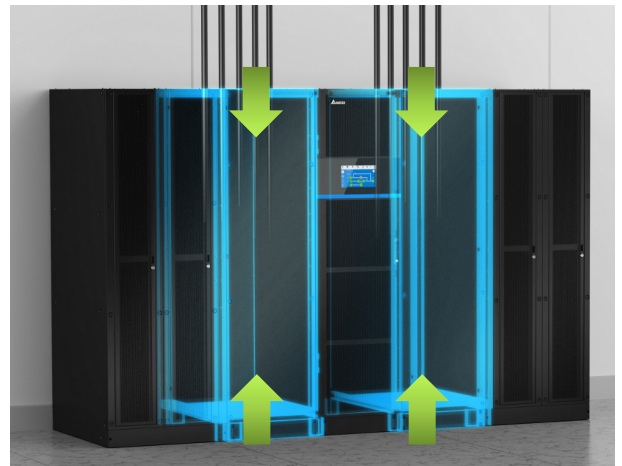

Top & bottom cable entry

Easy maintenance

DPM Gen2 provides full front access, featuring a power cell designed for effortless maintenance. Let's delve into the design structure of the model



DPM Gen2 system view

(1) Power Cabinets

Self-diagnosing 250 kW (300 kW) 3-phase power module for worry-free operation

(2) System Control Module

Apply redundant controller and auxiliary power to ensure high system availability

(3) Bypass Static Switch

Ensure full-rated operation, enabling smooth power source or circuit shifts

(4) Backfeed Contactor

Built-in safety feature ensures protection against reverse current flow

(5) IR Scan Window (optional)

With our Infrared (IR) transmissive window, you can effortlessly examine UPS external wiring, busbar, and screw temperatures through infrared inspection, all without opening the cabinet!

Options & Accessories

DPM Gen2 provides a full range of options and accessories that ensure your system operates at its peak.



Delta Lithium-ion Batteries

- UL 1973, IEC 62619, JIS C 8715-2 (S-Mark), UN38.3 certification and UL 9540A tested
- Up to 470 kW power and 62 kWh in a single cabinet
- Continues battery oversight and effortless management from UPS LCD
- External communication: CAN 2.0 (Dry contact), MODBUS RTU/ TCP
- Ultra long life: more than 4000 cycles⁽¹⁾
- Dimensions (W x D x H):
668 x 873 x 2100 mm (without top-hat)
668 x 873 x 2407 mm (with top-hat)



Integrated Battery Switch Cabinet

- Isolates the UPS from battery power
- Easy to monitor through leakage current display
- Dimensions (W x D x H): 600 x 875 x 1900 mm



Multifunctional Communication Card (MFC)

- Helps the UPS communicate with the lithium-ion battery system. This lets users monitor battery temperature, voltage, current, and alarms on the UPS's LCD
- Enables parallel communication between MFCs when UPSs operate in parallel

Other Accessories

- Grid interactive
- Advance failure prediction
- IR scan window
- DC battery ground fault defector
- EMS 1000: monitor temperature, humidity and other connected monitoring devices in a room environment.
- Battery management system
- Battery cabinet temperature sensor cable
- Integrated battery cabinet without switch
- Parallel cable
- Dust filter

(1) SOC range 90%-10%, 1C rate, 25°C, EOL: 70% SOH

Technical Specifications

Delta DPM Gen2 UPS 250-1750 kW (400 V)

Model	DPM G2-	250K	500K ⁽¹⁾	750K ⁽¹⁾	1000K	1250K	1500K ⁽¹⁾	1750K ⁽¹⁾	
Power Rating		250 kVA 250 kW	500 kVA 500 kW	750 kVA 750 kW	1000 kVA 1000 kW	1250 kVA 1250 kW	1500 kVA 1500 kW	1750 kVA 1750 kW	
Parallel Configuration		Up to 8 units							
INPUT									
Nominal Voltage		380/ 400/ 415 Vac, 3P3W+PE or 3P4W+PE							
Voltage Range		323-477 Vac (100% load)							
Frequency Range		40-70 Hz							
Total Harmonic Distortion (THDi)		< 3% (100% resistive load)							
Power Factor		> 0.99 (100% load)							
Short Circuit Withstand Current		65 kA				100 kA			
Connection		Single or dual feed							
OUTPUT									
Nominal Voltage		380/ 400/ 415 Vac, 3P3W+PE or 3P4W+PE							
Voltage Regulation		±1% (static)							
Frequency		50/60 ± 0.05 Hz							
Total Harmonic Distortion (THDv)		< 1% (linear load)							
Overload Capability		< 110%: continues; 110-125%: 10 mins; 126-150%: 1 min; > 150%: 1 sec							
Current Crest Ratio		3:1							
EFFICIENCY									
Online Mode		Up to 97.3%							
Clean Mode (VI)		Up to 99%							
BATTERY									
Battery Type		VRLA/ Vented lead-acid/ Lithium-ion/ Ni-Zinc							
Nominal Voltage		480 Vdc							
Quantity		34-35 ⁽²⁾ , 36-46 pcs (VRLA 12 V)							
Charge Current		125 A	250 A	375 A	500 A	625 A	750 A	875 A	
Protection Design		Battery shunt trip x1, Battery temperature detection x4, Battery breaker status dry contact x1							
COMMUNICATION INTERFACE									
Display		10-inch color touchscreen							
Port		Smart slot x2, MODBUS (RS-485) port x1, REPO port x1, Input dry contact x6, Output dry contact x6, Synchronized Multiple Bus (SMB) x2, Breaker status detection x4, EMS/Console port x1, Ethernet x1							
Protocols		SNMP, MODBUS RTU, MODBUS TCP/IP, HTTP(S), SNTP, SMTP, BOOTP, DHCP							
PHYSICAL									
Dimensions (W x D x H)		1030 x 990 x 2000 mm	* ⁽³⁾		3070 x 990 x 2000 mm	3400 x 900 x 2000 mm	* ⁽³⁾		
Net Weight		676 kg	* ⁽³⁾		2408 kg	2779 kg	* ⁽³⁾		
ENVIRONMENT									
Operating Temperature		0 to 40 °C							
Humidity		0-95% (non-condensing)							
Audible Noise		< 78 dBA	* ⁽³⁾		< 84 dBA	< 85 dBA	* ⁽³⁾		
Altitude		0-2000 m (derating 1%/100 m from 1001-2000 m)							
Ingress Protection Level		IP20							
CONFORMANCE									
Safety		IEC 62040-1, CE, UKCA							
EMC		IEC 62040-2							
Performance		IEC 62040-3							
Sustainability		RoHS, REACH, Energy Star 2.0							
FEATURES									
Standard		Advance power walk-in for generator, Backfeed protection with contactor, Burn-in test without load bank, Cold start function, Synchronized multiple bus (SMB), Frequency conversion, Battery shunt trip, Auxiliary power 48 Vdc for shunt trip							
Option		Advance failure prediction, Grid interactive, Software integration with Delta lithium battery BMS, DC battery ground fault detector, Integrated battery switch cabinet, IR scan window							

(1) Upcoming product

(2) 34-35 pcs require service setting and load derating

(3) To be released

All specifications are subject to change without prior notice.

Delta DPM Gen2 UPS 300-2100 kW (480 V)

Model	DPM G2-	300K ⁽¹⁾	600K ⁽¹⁾	900K ⁽¹⁾	1200K	1500K	1800K ⁽¹⁾	2100K ⁽¹⁾	
Power Rating		300 kVA 300 kW	600 kVA 600 kW	900 kVA 900 kW	1200 kVA 1200 kW	1500 kVA 1500 kW	1800 kVA 1800 kW	2100 kVA 2100 kW	
Parallel Configuration		Up to 8 units							
INPUT									
Nominal Voltage		480 Vac, 3P3W+PE							
Voltage Range		408-552 Vac (100% load)							
Frequency Range		40-70 Hz							
Total Harmonic Distortion (THDi)		< 3% (100% resistive load)							
Power Factor		> 0.99 (100% load)							
Short Circuit Withstand Current		65 kA				100 kA			
Connection		Single or dual feed							
OUTPUT									
Nominal Voltage		480 Vac, 3P3W+PE							
Voltage Regulation		±1% (static)							
Frequency		50/60 ± 0.05 Hz							
Total Harmonic Distortion (THDv)		< 1% (linear load)							
Overload Capability		< 110%: continues; 110-125%: 10 mins; 126-150%: 1 min; > 150%: 1 sec							
Current Crest Ratio		3:1							
EFFICIENCY									
Online Mode		Up to 97.5%							
Clean Mode (VI)		Up to 99.2%							
BATTERY									
Battery Type		VRLA/ Vented lead-acid/ Lithium-ion/ Ni-Zinc							
Nominal Voltage		480 Vdc							
Quantity		34-35 ⁽²⁾ , 36-46 pcs (VRLA 12 V)							
Charge Current		125 A	250 A	375 A	500 A	625 A	750 A	875 A	
Protection Design		Battery shunt trip x1, Battery temperature detection x4, Battery breaker status dry contact x1							
COMMUNICATION INTERFACE									
Display		10-inch color touchscreen							
Port		Smart slot x2, MODBUS (RS-485) port x1, REPO port x1, Input dry contact x6, Output dry contact x6, Synchronized Multiple Bus (SMB) x2, Breaker status detection x4, EMS/Console port x1, Ethernet x1							
Protocols		SNMP, MODBUS RTU, MODBUS TCP/IP, HTTP(S), SNTP, SMTP, BOOTP, DHCP							
PHYSICAL									
Dimensions (W x D x H)		1030 x 990 x 2000 mm	* ⁽³⁾		3070 x 990 x 2000 mm	3400 x 900 x 2000 mm	* ⁽³⁾		
Net Weight		675.5 kg	* ⁽³⁾		2408 kg	2779 kg	* ⁽³⁾		
ENVIRONMENT									
Operating Temperature		0 to 40 °C							
Humidity		0-95% (non-condensing)							
Audible Noise		< 78 dBA	* ⁽³⁾		< 84 dBA	< 85 dBA	* ⁽³⁾		
Altitude		0-2000 m (derating 1%/100 m from 1001-2000 m)							
Ingress Protection Level		IP20							
CONFORMANCE									
Safety		UL1778							
EMC		FCC Class A							
Performance		IEC 62040-3							
Sustainability		RoHS, REACH, Energy Star 2.0							
FEATURES									
Standard		Advance power walk-in for generator, Backfeed protection with contactor, Burn-in test without load bank, Cold start function, Synchronized multiple bus (SMB), Battery shunt trip, Auxiliary power 48 Vdc for shunt trip							
Option		Advance failure prediction, Grid interactive, Software integration with Delta lithium battery BMS, DC battery ground fault detector, Integrated battery switch cabinet, IR scan window							

(1) Upcoming product

(2) 34-35 pcs require service setting and load derating

(3) To be released

All specifications are subject to change without prior notice.

Delta: Your Complete Data Center Solution

In the data center landscape, robust power distribution is pivotal. Delta excels not only in highly reliable UPSs but also in PDUs, STSs, busways, and rPDUs. Uninterrupted power flow underpins efficiency and Delta delivers on every front.

Busway

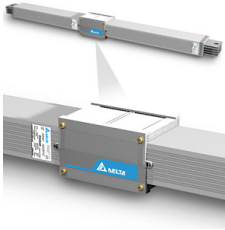

BL Series

- Rating: 400-6400 A
- IP68 certified, designed for outdoor use. Ultimate safeguard against water, dust, fire, shocks and corrosion
- Crafted with epoxy through vacuum casting to elevate safety and reliability
- Copper/ Aluminum conductor
- IEC 61439, UL 857 certified



BR Series

- Rating: 250-2000 A
- IP20 (IP55 option) for white space use
- Epoxy cast resin technology ensures high insulation to enhance safety and reliability
- Copper conductor above 99.9 %
- Successive plug-in slot
- Hot-swappable plug-in units
- IEC 61439, UL 857 certified



Static Transfer Switch (STS)

- Rating: 200/800/1800 A (Support for customization)
- Excellent reliability: provides redundant aux-power, control board and fan
- Hassle-free maintenance: modular design of STS and control board. Fully front access and support for top and bottom cable entry



Power Distribution Unit (PDU)

- Rating: 450/500/650/950 kVA (Support for customization)
- Robust resilience: adopts compartmentalized electrical components, redundant aux-power, K-factor isolation transformer
- Uplevel efficiency: natural convection cooling and DOE-compliant copper transformer
- Easy management: real-time & optional billing grade metering system



Rack Power Distribution Unit (rPDU)

- Basic, metered and switched type available (Support for customization)
- Space saving: supports Zero-U, vertical/horizontal, rear and side installation
- Effortless handling: network module for remote management
- Strong resilience: hydraulic-magnetic branch circuit breaker protection, certified plugs/receptacles withstands high temperatures in tough environments







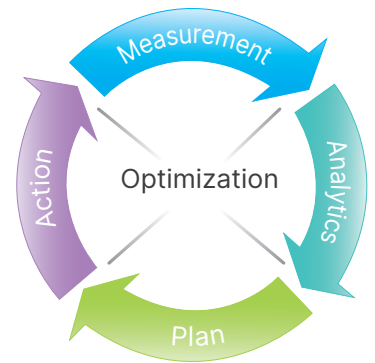



Data Center Infrastructure Management (DCIM)

One Tool. Complexity Mastered.

The most advanced datacenter monitoring solutions seamlessly unite individual systems within a unified central platform. The Delta Data Center Infrastructure Management (DCIM) system merges all tasks related to datacenter facilities and IT equipment management onto a single platform. Effectively oversee energy, power systems, cooling, environment, security, asset management, server monitoring, and more across multiple sites. The system incorporates advanced alert algorithms across the infrastructure, aiding in resource optimization and reducing the risk of downtime.



Product Modules

 <p>1 Operation</p> <ul style="list-style-type: none"> Power Cooling Environment Security IT Device 	 <p>3 PUE Energy</p> <ul style="list-style-type: none"> PUE/ EUI Electricity Cost Energy Analysis 	 <p>4 Capacity</p> <ul style="list-style-type: none"> Capacity Analysis Best Installation Position Capacity Plan 	 <p>2 Smart Energy</p> <ul style="list-style-type: none"> Energy Optimization Precision Control Abnormality Prediction 	 <p>5 BIM 3D</p> <ul style="list-style-type: none"> 3D Navigation Device Summary Event Highlight
 <p>Incident</p> <ul style="list-style-type: none"> Assign Owner Search History Classification Business Impact Business Risk 	 <p>Asset</p> <ul style="list-style-type: none"> Asset Model Document Quick Search Connectivity Failure Impact 	 <p>Work Order</p> <ul style="list-style-type: none"> Template Schedule/ Event Trigger Statistics and History 	 <p>Asset Inspection</p> <ul style="list-style-type: none"> On-site Audit App Download Plan Executing History Data Analysis 	 <p>Analytics</p> <ul style="list-style-type: none"> Predict Trend Capacity Forecast Modeling

1 Data center one-stop management



2 Smart Energy dashboard

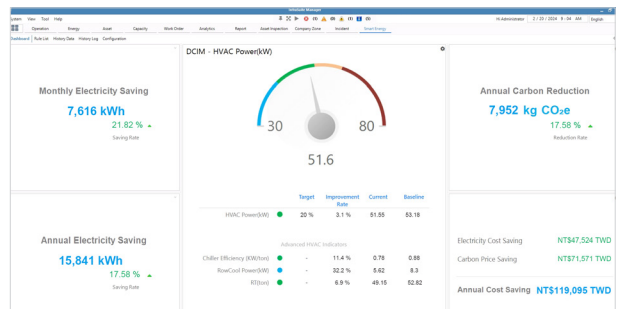

3 PUE analysis

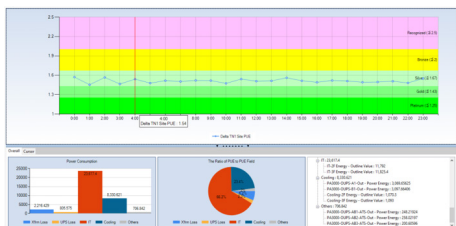

4 Automatic availability calculation

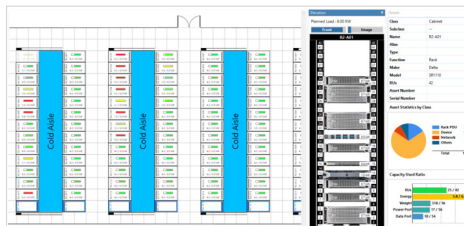

5 Data center 3D visualized layout

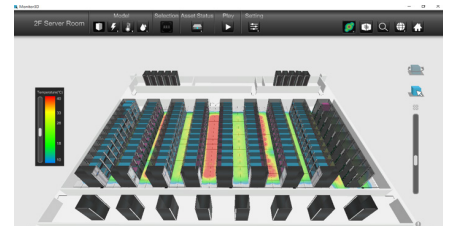



About Delta

Delta, established in 1971, is a global leader in power supplies and thermal management, delivering innovative solutions for power management, data center infrastructure, industrial automation, telecom, EV charging, and more. With a footprint in almost 200 locations across 5 continents, Delta's commitment to sustainability is underscored by prestigious awards, including the double A List from CDP in 2020 and 2022. This achievement highlights our unwavering dedication to sustainability, emphasized by our six-year consecutive recognition as the CDP's Supplier Engagement Leader.