

# Galaxy VX

Highly efficient, scalable, 3-phase power protection with flexible operating modes and eConversion for large facilities, data centers, and business-critical applications.

500 kW to 1500 kW  
380 V / 400 V / 415 V / 440 V / 480 V



Life Is On

**Schneider**  
Electric

# Scalable, flexible, high-performance power protection

## Meet the changing needs of your rapidly expanding business

Galaxy VX is a highly efficient, modular 3-phase UPS scalable from 500 kW to 1500 kW that provides high performance, scalability, and flexibility. Its scalability accommodates the changing needs of your growing business, and its exceptional performance and abundance of cost-saving features reduce your energy costs and total cost of ownership (TCO). Galaxy VX is the ideal UPS for today's large data centers, cloud, and colocation facilities, as well as mission-critical applications.

- Reduces TCO with up to 99% efficient, third-party certified Class 1 eConversion operating mode
- Enables on-site UPS expandability with 250 kW power cabinets and the ability to parallel up to four units for capacity or redundancy
- Improves UPS reliability and lifecycle with patented four-level inverter technology
- Optimizes your return on investment, and increases your UPS and energy storage utilization, with dispatchable operation
- Speeds up your deployment time, increases on-site reliability, and reduces start-up costs with Smart Power Test (SPoT) mode
- Compatible with low TCO, high-performance Lithium-ion batteries
- Lowers maintenance and replacement costs with modular architecture

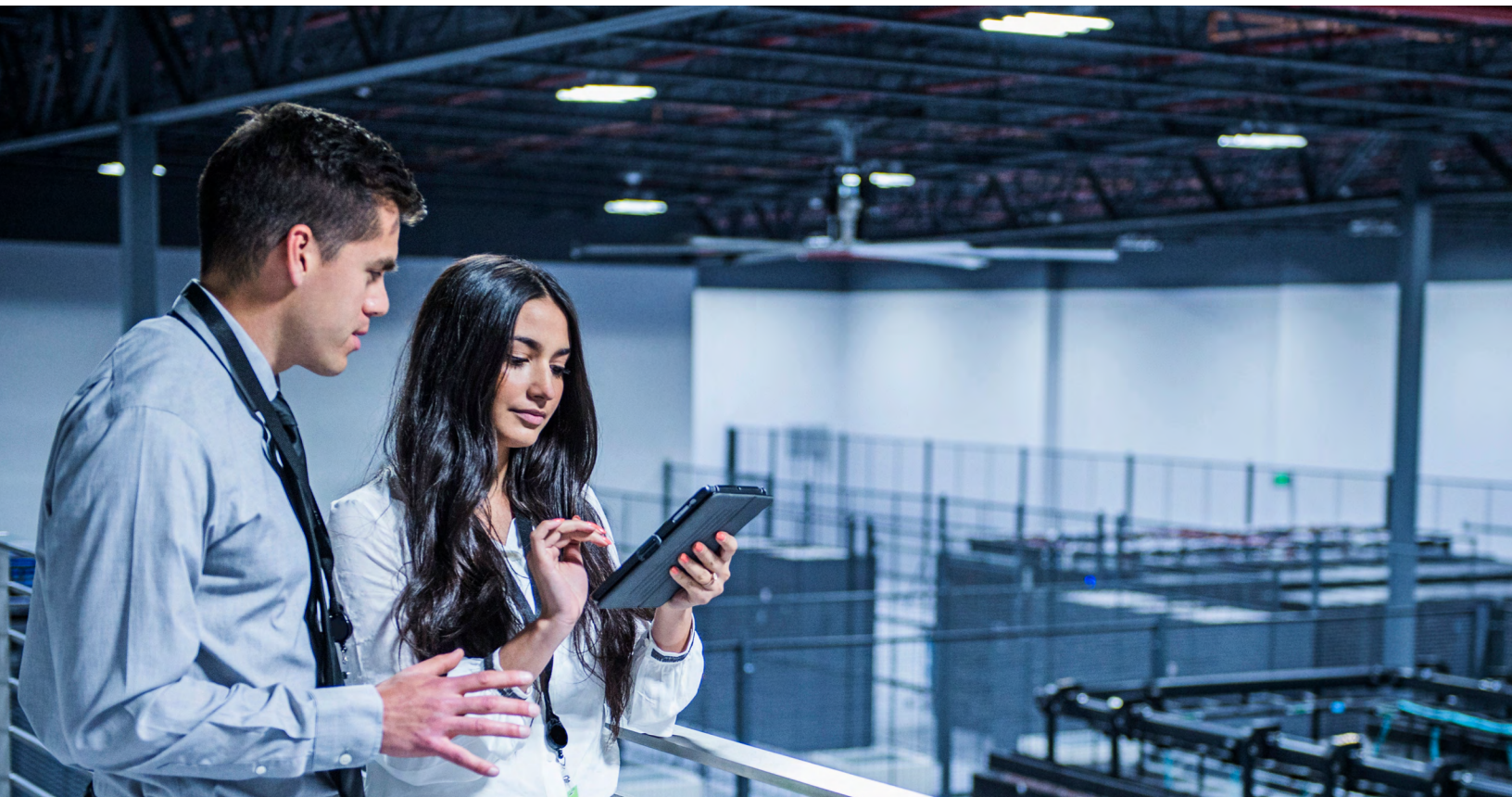

# Key advantages and innovations



## 99% efficient in patented eConversion mode

Recover your initial investment within 2–3 years through energy savings.



## Patented hybrid technology

Provides up to 96.5% efficiency in double conversion mode.



## Battery flexibility, including Lithium-ion batteries\*

Increase availability and reduce TCO with long-life, intelligent energy storage.



## Grid interactive solution

Maximize savings, generate revenue, and improve resiliency by dispatching stored battery capacity or deploying fast frequency reserve\* support.

*\*Contact your local representative for availability.*



## Maximum availability thanks to modular architecture

Critical system components built as modules for faster serviceability and fault tolerance. N+1 redundancy and scalability options available.



## EcoStruxure IT

Monitor, manage, and model your IT infrastructure, and get service support, anytime, anywhere.\*

## Well-suited for a wide range of data center and industrial applications



### Data center

- Large and extra-large data centers
- Cloud and colocation facilities



### Transportation

- Lighting
- Air traffic control
- Security
- Signaling and communication systems



### Healthcare

- Radiology and imaging equipment
- Operating rooms and Intensive Care Units
- Emergency power systems



### Minerals, Metals & Mining

- Furnace process control
- Glass plants



### Oil & gas

- Refining
- Petrochemicals
- Gas processing control
- Well pumps



### Power & Grid

- Thermal plants
- Generator protection
- Hydro turbine control
- Wind farm monitoring



### Industrial processes

- Semiconductor manufacturing

# Premium protection and sustainability

eConversion: an unbeatable combination of power quality and high efficiency

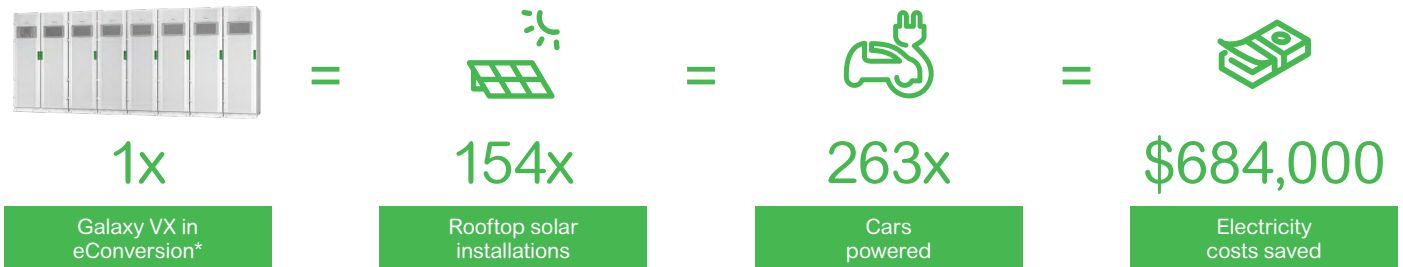

## Sustainably reduce your operating costs

Protect power to your load, reduce your total cost of ownership and electricity consumption, and meet your sustainability goals with up to 99% efficient, Class 1-compliant eConversion mode for Galaxy V-series UPSs, the recommended operating mode for your Galaxy V-series UPS.\*

- By operating at up to **99% efficiency**, the electricity savings in eConversion within 10 years typically equals **3x the price of the UPS**.
- The inverter operates continuously, protecting the load with **no transfer time**. eConversion performance has been certified with the same IEC 62040-3 **Class 1** rating as double conversion mode.
- eConversion mode recharges batteries and provides power factor correction and harmonics compensation, making it a **versatile solution for IT and non-IT loads**.
- Since its launch in 2014, eConversion has been successfully deployed all over the world. Join thousands of customers who use it daily to protect their critical loads.

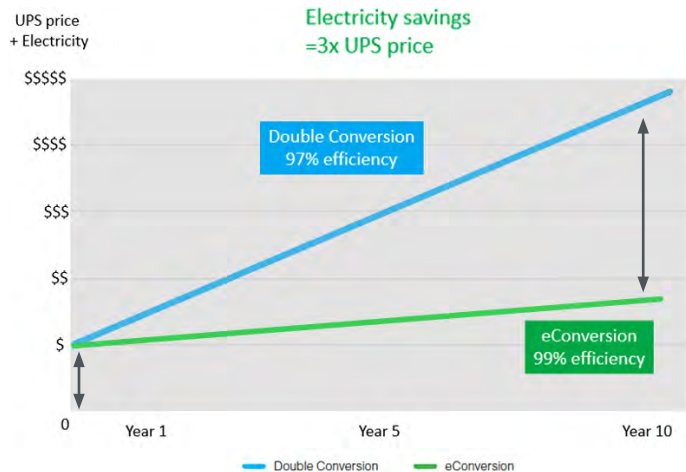

## Calculate your savings

Use our eConversion vs. Double Conversion Calculator to quickly assess your potential energy savings, operating cost optimization, and CO<sub>2</sub> emissions reduction by comparing the cost of running your Galaxy V-Series UPS in eConversion mode vs. double conversion mode.



Scan the QR code with your phone camera, or [click here](#) to access the calculator from the Schneider Electric Data Center Trade Off Tools™ Web page.

[Learn more about eConversion](#)

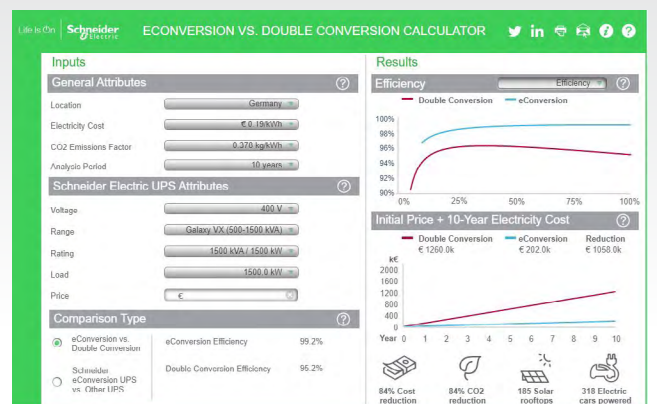

\*Model dependent; based on a market electricity price: \$0.15 /kWh. The annual electricity savings are calculated by comparing the UPS efficiency in eConversion mode vs. double conversion mode.

# Simple scalability

## Modular design

The Galaxy VX system scales using 250 kW power cabinets. Power cabinets can be added after initial installation to allow for load growth or increased redundancy.

## Expand Galaxy VX from 500 kW up to 1500 kW N+1

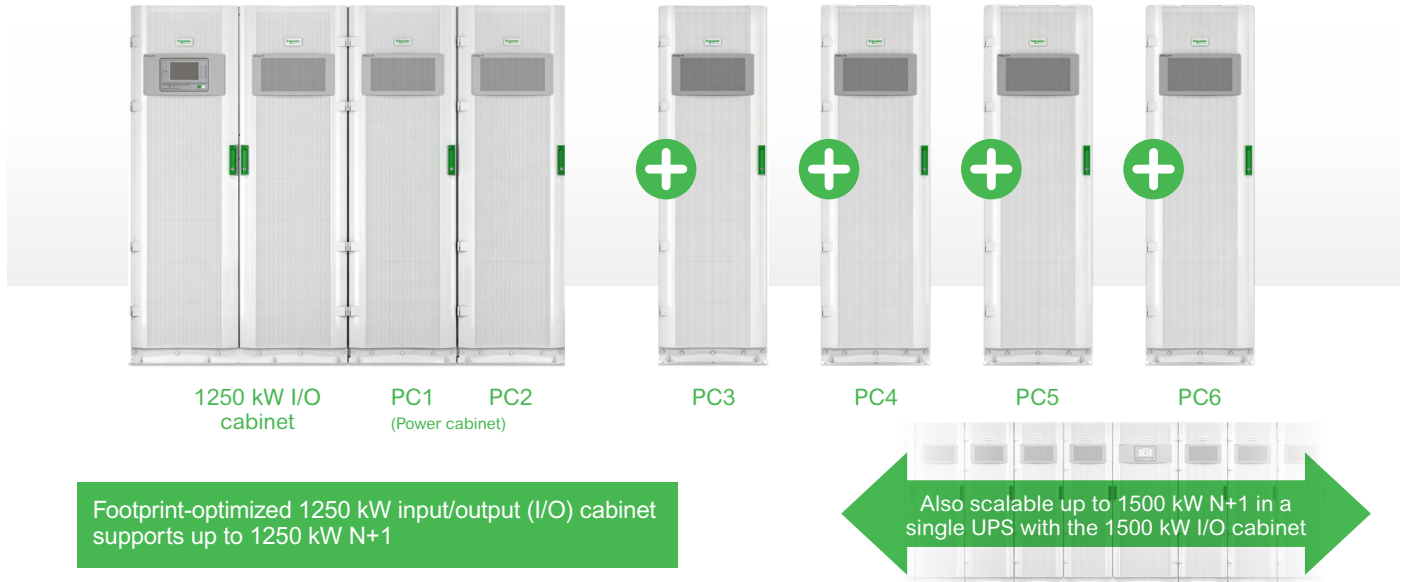

# Flexible, optimized, long-life energy storage with lithium-ion

## Save space and the environment

As a first mover with a vast installed base, Schneider Electric has developed its own Galaxy Lithium-ion battery solution that also delivers these benefits:

- Optimize TCO and achieve sustainability targets by **doubling** your battery life
- Recharge **2-3x faster** than VRLA solutions
- Simplify and speed up installation with our internal power supply
- Enhance battery safety with three levels of battery management system (BMS)

To learn more about Lithium-ion battery solutions, visit: [www.se.com/li-ion](http://www.se.com/li-ion)

## Lithium-ion compared to VRLA batteries

Four circular icons in green, each containing a white icon and text:

- Higher** operating temp. (less cooling)
- 2 – 3X** expected life
- 60 – 70%** less weight
- 2 – 3X** Faster recharge



# Increase reliability and streamline deployment

Speed up deployment time, reduce start-up costs, and increase onsite reliability of the UPS operation by using the Smart Power Test (SPoT) mode before connecting your critical load.

## SPoT (Smart Power Test)

SPoT enables the field service engineer (FSE) to test the UPS with full capacity current flow through important components and converters, without using a large system input current and without needing a load bank connected to the system or other system modifications.

- Simple, easy, and safe method to test the UPS at full power
- Can be conducted after service, repair, upgrade, or commissioning of UPS installation to verify system is properly installed
- Reduce risk to load and improve product quality
- Significant cost, time, and power savings

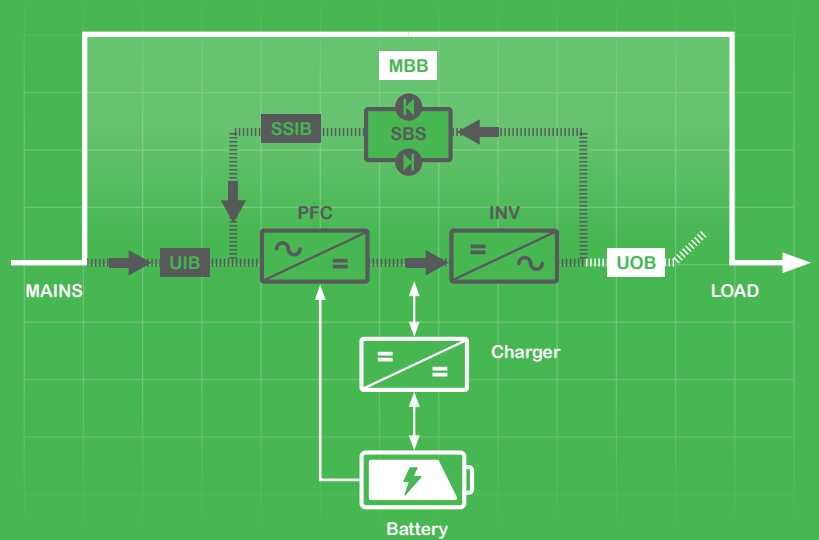

Increase reliability and peace of mind by adding a power module cabinet to achieve N+1 redundancy, or by paralleling up to four UPSs for capacity or redundancy.

### Smart paralleling and fault-tolerant design

Galaxy VX inherently redundant design allows for any power cabinet to act as a redundant 250 kW block. Load sharing in parallel is done by matching the percentage output of each system depending on capacity availability. Redundant parallel communication cables increase overall system resiliency.

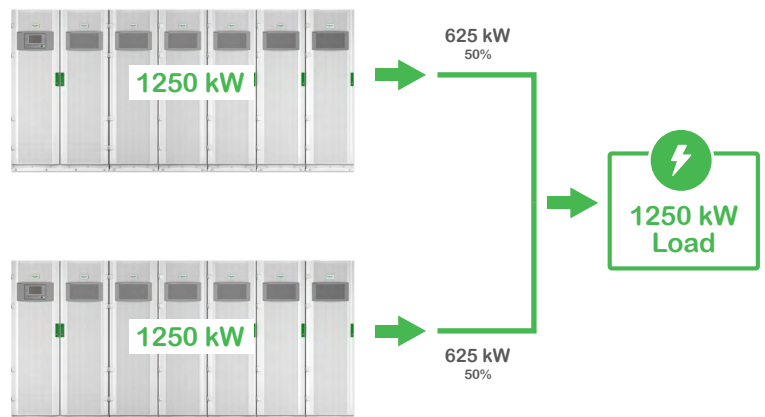

# Installation and serviceability

## Convenient installation

- Fast and easy installation provided by Schneider Electric field service team
- Power cabinets with casters roll into place
- HMI display includes network communication card
- Install back to back or against a wall
- Compatible with skid and containerized systems
- Secure installation with mechanical anchoring brackets
- OSHPD seismic rating certification

## Designed for efficient service

- Front access only for all service and repair tasks
- Field replaceable power modules
- Modular fault-tolerant power blocks reduce mean time to repair



## Inside the Galaxy VX redundant and scalable UPS

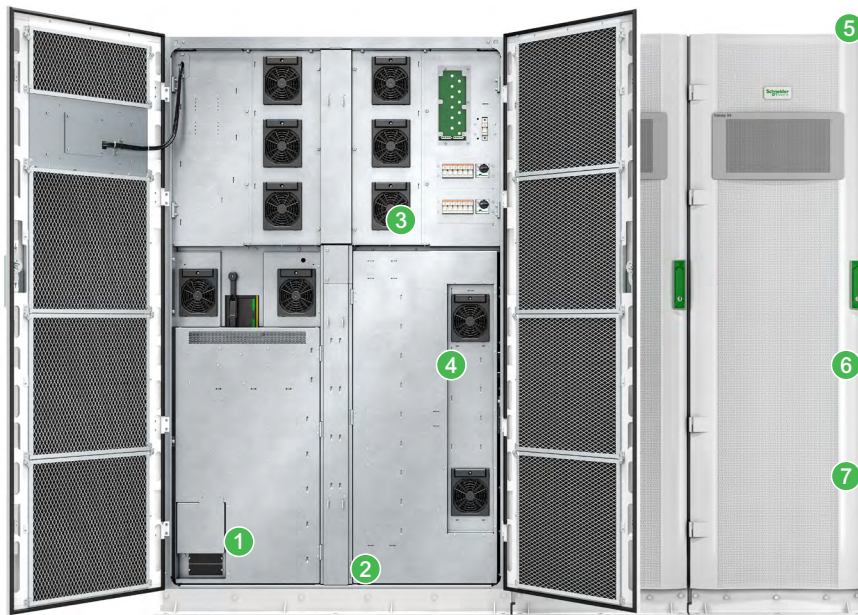

- 1 Backfeed contactor**  
Included in the UPS to meet local electrical codes and increase user safety
- 2 Redundant power supply**  
Included in the I/O cabinet to enhance reliability
- 3 Static switch**  
Fully rated, with front-to-back airflow
- 4 Main controller / bypass controller redundancy**  
If the main controller goes offline, the bypass controller will operate the UPS
- 5 Fiber optic communication**  
Fast and clear internal communication increases system reliability
- 6 Power modules in power cabinet**  
42 kW single phase power block is easy to replace with a low mean time to repair (MTTR)
- 7 Replaceable fans**  
Replace fans while the UPS is online

# Grid Interactive Solution

**Unlock the value of your UPS:** Maximize savings, generate revenue, and improve resiliency by dispatching stored battery capacity.

Lithium-ion batteries are increasingly being utilized to provide a variety of valuable grid services and generate steady income streams. With modern data centers leveraging Lithium-ion battery technology, such income streams are also available to data center owners. This added functionality enables quick return on investment while increasing system reliability and providing continuous state of health data.

- **Participate in grid frequency stabilization**
  - Reduce load on the grid by activating UPS storage
  - This Fast Frequency Reserve (FFR) program is available through the NORDEL grid in Norway, Finland, Sweden, and Denmark
- **Increase system reliability**
  - Improves overall performance by cycling batteries to validate their state of health
- **Generate new revenue streams**
  - Create additional revenue by participating in utility programs and electricity markets

## Fast Frequency Reserve support

- **Receive compensation** for participating to grid frequency stabilization by discharging the UPS batteries
- **Battery capacity:** any (maximum demand: deliver 10-30 seconds of support)
- **Region:** Norway, Finland, Sweden, Denmark (DK2)
- **Annual earnings:** annual market auction (2021 prices were between 25k€ to 80k€ per MW)
- **Annual full battery cycles (maximum):** 5



To learn more about the Grid Interactive Solution, contact your Schneider Electric sales representative.



## Maximize asset utilization by combining a dispatchable UPS and Lithium-ion batteries with EcoStruxure Microgrid Advisor (EMA)

Reduce risk with the Galaxy VX UPS platform while creating additional value by dispatching lithium-ion batteries. The cloud-based EMA software platform automatically enables energy savings by optimizing loads with available resources, and can also enable a variety of other types of grid-supporting features, such as frequency support.

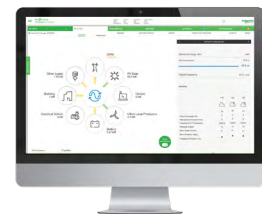

### Galaxy VX UPS

- 24x7 power protection for mission-critical applications
- Modular power solutions for maximum flexibility and reliability
- Ultra-high efficiency, with eConversion operating mode to further reduce energy consumption
- Load protection and peace of mind even when dispatch functions are performed

### Lithium-ion batteries

- High cycling capability, increased reliability, and longer life vs. lead-acid batteries
- High energy density allows for smaller footprint, translating to space savings
- Improved predictability and manageability via continuous battery monitoring
- Reduced TCO and simplified maintenance

### EcoStruxure Microgrid Advisor

- Advanced model predictive control algorithms autonomously enable maximum energy savings while optimizing battery life
- Stay informed of energy usage, savings, and battery reserve via EMA app and Web site
- System reliability via 24-hour advanced automatic default operation schedules
- Cyber-secure platform to protect site and related data from external hacks.
- To learn more about EMA, visit: [www.se.com/ema](http://www.se.com/ema)



To learn how much you can save or earn with this Grid Interactive Solution, contact your local Schneider Electric representative.

# Visibility and peace of mind

## EcoStruxure IT enables resilient, secure, and sustainable data centers and IT environments

Schneider Electric's comprehensive Data Center Infrastructure Management (DCIM) solution, EcoStruxure IT, ensures business continuity by enabling secure monitoring, management, insights, planning, and modeling – whether from a single IT rack to hyper-scale IT – on-premises, in the cloud, and at the edge.



Resilient



Secure



Sustainable

### Easy visibility

Monitoring and management software streamlines data center device management:

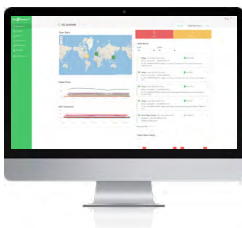

**EcoStruxure IT Expert** provides you a hands-on approach with **cloud-based** monitoring software that synthesizes and analyzes performance and alert data into proactive recommendations and enables wherever-you-go visibility from any device. Try it now: [www.ecostruxureit.com/ecostruxure-it-expert/#trial](http://www.ecostruxureit.com/ecostruxure-it-expert/#trial)

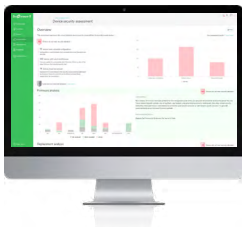

**EcoStruxure Data Center Expert** is a scalable end-to-end **on-premise** monitoring software that collects, organizes, and distributes critical device information, providing a comprehensive view of your company-wide, multi-vendor physical infrastructure.

### 24/7 peace of mind

Digital services proactively monitor your critical devices:



**EcoStruxure Asset Advisor\*** for secure power and cooling provides you a hands-off approach with 24/7 remote monitoring service by the Schneider Electric Connected Services Hub experts.

We monitor and troubleshoot, you relax.

### Operations, optimized

Planning and modeling software transforms data into performance insights:



**EcoStruxure IT Advisor** is a data center infrastructure planning and modeling solution that provides Data Center Managers in large enterprises and colocation data centers with full insights into their infrastructure to improve profitability, sustainability, and resiliency.

\* Contact your local representative for availability.

### Comprehensive on-site services

#### Start-up service: included with UPS

- Commission the installation in accordance with manufacturer's recommendations. Ensure optimal system performance from Day 1

#### Schneider Electric-certified installation services

- Expert configuration of your equipment for optimal performance and reliability

#### Maintenance services

- Ensure proper care of your mission-critical applications
- Preventive maintenance and response time upgrades, where available

#### Flexible service plans/ on-site extended warranty

- Hassle-free system maintenance
- Improve uptime at a predictable cost

# Technical specifications

Galaxy VX Technical Specs	500 kW to 1500 kW UPS
Topology	On-line double conversion with eConversion mode
Nominal Power (kVA)	500-1250 kW (1250 kW input/output cabinet) 500-1500 kW (1500 kW input/output cabinet)
Technical Power Ratings	500 kW, 625 kW, 750 kW, 800 kW, 1000 kW, 1100 kW, 1250 kW, 1500 kW
Parallel capability	Up to 4 units (N+1)
<b>Input</b>	
Rectifier Type	IGBT active rectifier
Nominal Input Voltage	380 V / 400 V / 415 V / 440 V / 480 V, 3-wire (3PH + PE) or 4-wire (3PH + PE + N) (600 V with optional external transformer)
Input Voltage Range	+20% / -15%
Input Connection	Single or dual feed
Input Frequency	50 or 60 Hz nominal (40-70 Hz)
Input Current Total Harmonic Distortion (THDI)	< 3% @ 100% load
Input Power Factor	> 0.99
Walk-in	0 to 300s (configurable)
Short Circuit Withstand Rating	100 kA
<b>Output</b>	
Inverter Type	4 Level IGBT, high efficiency, transformerless
Nominal Output Voltages	380 V / 400 V / 415 V / 440 V / 480 V, 3-wire (3PH + PE) or 4-wire (3PH + PE + N) (600 V with optional external transformer)
Load Power Factor	0.7 leading to 0.5 lagging without UPS derating
Voltage Regulation	+/- 1%
Frequency Regulation	50/60 Hz +/- 0.1% (free running)
Overload in Normal Operation (at 40 °C)	Continuous up to 110% 10 minutes up to 125% 1 minute up to 150%
Overload in Bypass Operation (at 40 °C)	Continuous up to 110% (380 V / 400 V / 415 V / 440 V) Continuous up to 125% (480 V) 1 minute up to 150% (all voltages)
Output Voltage Distortion (THDU)	<2% at 100% linear load; <3% at 100% nonlinear load
Output Power Factor	1.0 kVA = kW
<b>Efficiency details</b>	
Double conversion mode	Up to 96.5%
eConversion mode	Up to 99%
<b>Energy storage parameters</b>	
Type	Lithium-ion, VRLA, Wet Cell, Flywheel
Nominal DC Bus Voltage	480 VDC
Common battery string	Yes (VRLA only)

Galaxy VX Technical Specs	500 kW to 1500 kW UPS
<b>Communication</b>	
Multilingual Graphics LCD Display	Yes
Compatibility with APC Communication cards	AP9630
Communication Details	Modbus TCP/IP, SNMP, Email Modbus RS-485 (optional)
<b>Mechanical dimensions</b>	
<b>1250 kW I/O Cabinet (H x W x D)</b>	
500 kW	77.6 x 94.4 x 35.4 in (1970 x 2400 x 900 mm)
625/750 kW	77.6 x 118.1 x 35.4 in (1970 x 3000 x 900 mm)
800/1000 kW	77.6 x 141.6 x 35.4 in (1970 x 3600 x 900 mm)
1100/1250 kW	77.6 x 165.2 x 35.4 in (1970 x 4200 x 900 mm)
1250 kW N+1	77.6 x 188.8 x 35.4 in (1970 x 4800 x 900 mm)
<b>1500 kW I/O Cabinet (H x W x D)</b>	
500kW	77.6 x 126 x 35.4 in (1970 x 3200 x 900 mm)
750kW	77.6 x 149.6 x 35.4 in (1970 x 3800 x 900 mm)
1000 kW	77.6 x 173.2 x 35.4 in (1970 x 4400 x 900 mm)
1250 kW	77.6 x 196.9 x 35.4 in (1970 x 5000 x 900 mm)
1500 kW	77.6 x 220.5 x 35.4 in (1970 x 5600 x 900 mm)
1500 kW N+1	77.6 x 245.1 x 35.4 in (1970 x 6200 x 900 mm)
<b>Standards and approvals</b>	
Performance and Safety	UL 1778 5th edition, cUL CE, IEC 62040-1 IEC 62040-3 (VFI-SS-111)
EMC Emissions	FCC 47 Part 15 IEC 62040-2
Seismic	OSHPD IBC 2012
Surge	ANSI 62.4/B3
IP level (Ingress Protection)	IP20
<b>Environment</b>	
Operating Temperature	0–40 °C (32 – 104 °F) without derating
Humidity	0–95% noncondensing
Elevation / Altitude	1000 m (3333 ft) 100% load without derating
<b>Standard features</b>	
Soft Start, Walk-in Charger for Compatibility with Gensets	Yes, Adaptive, Configurable 1 to 300s
Cold Start Function (start without mains)	Yes
Emergency Stop (EPO)	No
Frequency Converter	Yes
Backfeed Protection	Yes
Smart Power Test (Spot)	Yes

Life Is On



To learn more about the Galaxy VX UPS and EcoStruxure IT DCIM, contact your Schneider Electric representative or visit [se.com/ups](https://se.com/ups)

**About Schneider Electric** At Schneider Electric, we believe access to energy and digital is a basic human right. We empower all to **make the most of their energy and resources**, ensuring **Life Is On** everywhere, for everyone, at every moment. We provide **energy and automation digital** solutions for **efficiency and sustainability**. We combine world-leading energy technologies, real-time automation, software and services into integrated solutions for Homes, Buildings, Data Centers, Infrastructure and Industries. We are committed to unleash the infinite possibilities of an **open, global, innovative community** that is passionate about our **Meaningful Purpose, Inclusive and Empowered** values.

© 2023 Schneider Electric. All Rights Reserved. Schneider Electric | Life is On, EcoStruxure, Facility Expert, Facility Advisor are trademarks and the property of Schneider Electric SE, its subsidiaries and affiliated companies.