



# Operation Manual

## Smart-UPS<sup>TM</sup> C Uninterruptible Power Supply

1000/1500/2000/3000 VA

120/230 Vac

Rack-Mount 2U

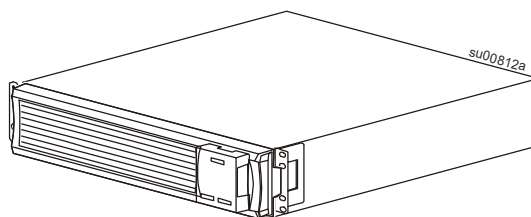

**For Professional Business Applications – Not For Consumer Use**

# Important Safety Messages

SAVE THESE INSTRUCTIONS - This manual contains important instructions that should be followed during installation and maintenance of the Smart-UPS and batteries.

Read these instructions carefully and look at the equipment to become familiar with the device before trying to install, operate, service or maintain it. The following special messages may appear throughout this document or on the equipment to warn of potential hazards or to call attention to information that clarifies or simplifies a procedure.



The addition of this symbol to either a “Danger” or “Warning” safety label indicates that an electrical hazard exists which will result in personal injury if the instructions are not followed.



This is the safety alert symbol. It is used to alert you to potential personal injury hazards. Obey all safety messages that follow this symbol to avoid possible injury or death.

 <b>DANGER</b>
<b>DANGER</b> indicates a hazardous situation which, if not avoided, will result in death or serious injury.
 <b>WARNING</b>
<b>WARNING</b> indicates a hazardous situation which, if not avoided, could result in death or serious injury.
 <b>CAUTION</b>
<b>CAUTION</b> indicates a hazardous situation which, if not avoided, could result in minor or moderate injury.
<b>NOTICE</b>
<b>NOTICE</b> is used to address practices not related to physical injury.

## Product Handling Guidelines

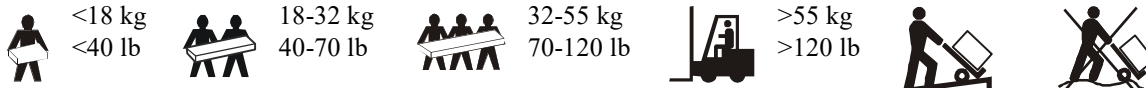

# Safety and General Information

**Inspect the package contents upon receipt.**

**Notify the carrier and dealer if there is any damage.**

- Adhere to all national and local electrical codes.
- All wiring must be performed by a qualified electrician.
- Changes and modifications to this unit not expressly approved by Schneider Electric could void the warranty.
- This UPS is intended for indoor use only.
- Do not operate this unit in direct sunlight, in contact with fluids, or where there is excessive dust or humidity.
- Be sure the air vents on the UPS are not blocked. Allow adequate space for proper ventilation.
- For a UPS with a factory installed power cord, connect the UPS power cable directly to a wall outlet. Do not use surge protectors or extension cords.
- The UPS input ground conductor must be properly bonded to protective earth at the service panel. If the UPS input power is supplied by a separately derived system, the ground conductor must be properly bonded at the supply transformer or motor generator set.
- For a UPS with a factory installed power cord, connect the UPS power cable directly to a wall outlet. Do not use surge protectors or extension cords.
- The UPS input ground conductor must be properly bonded to protective earth at the service panel. If the UPS input power is supplied by a separately derived system, the ground conductor must be properly bonded at the supply transformer or motor generator set.
- The equipment is heavy. Always practice safe lifting techniques adequate for the weight of the equipment.

## Battery safety

### CAUTION

#### **RISK OF HYDROGEN SULPHIDE GAS AND EXCESSIVE SMOKE**

- Replace the battery at least every 5 years or at the end of its service life, whichever is earlier.
- Replace the battery immediately when the UPS indicates battery replacement is necessary.
- Replace batteries with the same number and type of batteries as originally installed in the equipment.
- Replace the battery immediately when the UPS indicates a battery overtemperature condition, or when there is evidence of electrolyte leakage. Power off the UPS, unplug it from the AC input, and disconnect the batteries. Do not operate the UPS until the batteries have been replaced.
- \*Replace all battery modules (including the modules in External Battery Packs) which are older than one year, when installing additional battery packs or replacing the battery module(s).

**Failure to follow these instructions could result in equipment damage and minor or moderate injury.**

\*Contact APC by Schneider Electric Worldwide Customer Support to determine the age of the installed battery modules.

- Servicing of user replaceable batteries should to be performed or supervised by personnel knowledgeable about batteries and required precautions. Keep unauthorized personnel away from batteries.
- It is not necessary to ground the battery system. The user has the option of referencing the battery system to chassis ground at either a positive or negative battery terminal.

- Batteries typically last for two to five years. Environmental factors impact battery life. Elevated ambient temperatures, poor quality utility power, and frequent short duration discharges will shorten battery life. Batteries should be replaced before end of life.
- Schneider Electric uses Maintenance-Free sealed Lead Acid batteries. Under normal use and handling, there is no contact with the internal components of the battery. Over charging, over heating or other misuse of batteries can result in a discharge of battery electrolyte. Released electrolyte is toxic and may be harmful to the skin and eyes.
- CAUTION: Before installing or replacing the batteries, remove jewelry such as wristwatches and rings. High short circuit current through conductive materials could cause severe burns.
- CAUTION: Do not dispose of batteries in a fire. The batteries may explode.
- CAUTION: Do not open or mutilate batteries. Released material is harmful to the skin and eyes and may be toxic.
- CAUTION: Failed batteries can reach temperatures that exceed the burn thresholds for touchable surfaces.
- CAUTION: A battery can present a risk of electrical shock and high short circuit current. The following precautions should be observed when working on batteries:
  - Disconnect the charging source prior to connecting or disconnecting battery terminals.
  - Do not wear any metal objects including watches and rings.
  - Do not lay tools or metal parts on top of batteries.
  - Use tools with insulated handles.
  - Wear rubber gloves and boots.
  - Determine if battery is either intentionally or inadvertently grounded. Contact with any part of a grounded battery can result in electric shock and burns by high short-circuit current. The risk of such hazards can be reduced if grounds are removed during installation and maintenance by a skilled person.

### Deenergizing safety

The UPS contains internal batteries and may present a shock hazard even when disconnected from the branch circuit (mains). Before installing or servicing the equipment check that the:

- Input circuit breaker is in the **OFF** position.
- Internal UPS batteries are removed.

## Radio Frequency Warning

**WARNING:** This is a category C2 UPS product. In a residential environment, this product may cause radio interference, in which case the user may be required to take additional measures.

**Note:** This equipment has been tested and found to comply with the limits for a Class A digital device, pursuant to part 15 of the FCC Rules. These limits are intended to provide reasonable protection against harmful interference when the equipment is operated in a commercial environment. This equipment generates, uses, and can radiate radio frequency energy and, if not installed and used in accordance with the instruction manual, may cause harmful interference to radio communications. Operation of this equipment in a residential area is likely to cause harmful interference in which case the user will be required to correct the interference at his own expense.

# Product Description

The APC™ by Schneider Electric Smart-UPS™ C is a high performance uninterruptible power supply (UPS). The UPS provides protection for electronic equipment from AC power blackouts, brownouts, sags, and surges, small AC power fluctuations and large disturbances. The UPS also provides battery backup power for connected equipment until AC power returns to acceptable levels or the batteries are completely discharged.

This user manual is available on the enclosed Documentation CD and on the APC by Schneider Electric web site, [www.apc.com](http://www.apc.com).

## Specifications

For additional specifications, refer to the APC by Schneider Electric web site at [www.apc.com](http://www.apc.com).

### Physical

	UPS + Battery	Battery
<b>Weight specifications</b>	1000 VA models 20.48 kg (45.15 lb)	5.6 kg (12.32 lb)
	1500 VA models 27.8 kg (61.20 lb)	10 kg (22 lb)
	2000 VA models 26.2 kg (57.76 lb)	10 kg (22 lb)
	3000 VA models 41 kg (90.38 lb)	19 kg (41.80 lb)

### Environmental

<b>Temperature</b>	<b>Operating</b>	0° to 40° C (32° to 104° F)
	<b>Storage</b>	-15° to 45° C (5° to 113° F) charge UPS battery every six months
<b>Maximum Elevation</b>	<b>Operating</b>	3,000 m (10,000 ft)
	<b>Storage</b>	15,000 m (50,000 ft)
<b>Humidity</b>		0% to 95% relative humidity, non-condensing
<b>International Protection Code</b>		IP20
<b>Pollution degree</b>		2
<b>Overvoltage category</b>		II
<b>Applicable power grid power distribution system</b>		TN Power System
<b>Applicable standard</b>		IEC 62040-1
<b>Battery Type</b>		Maintenance free, sealed lead acid

# Product Overview

## Front panel features

- ❶ Display interface
- ❷ Bezel
- ❸ Battery
- ❹ Internal battery connector

1000VA 120/230 Vac

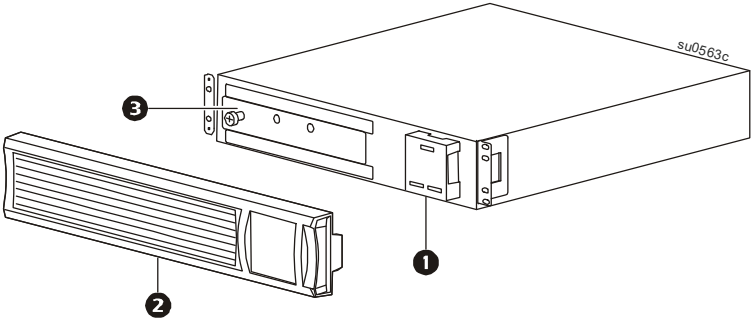

3000 VA 230 Vac

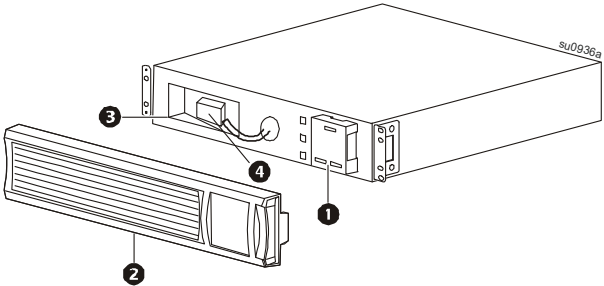

1500 VA 120/230 Vac  
2000 VA 230 Vac

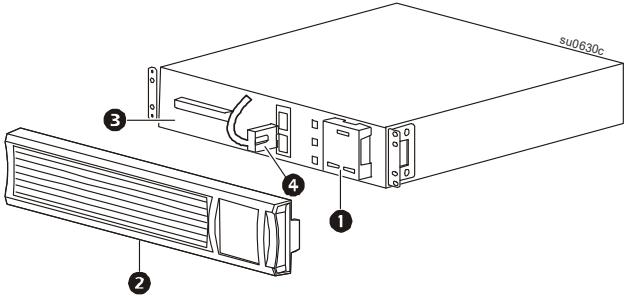

## Rear panel features

1000 VA 120 Vac

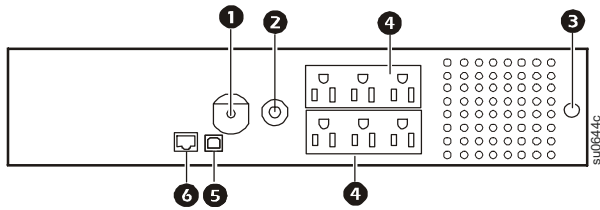

1000 VA 230 Vac

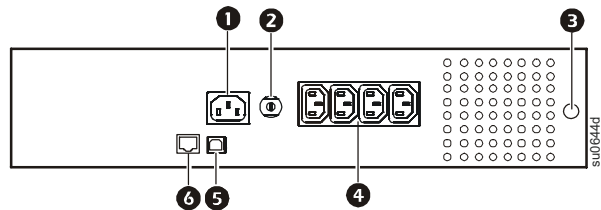

1500 VA 120 Vac

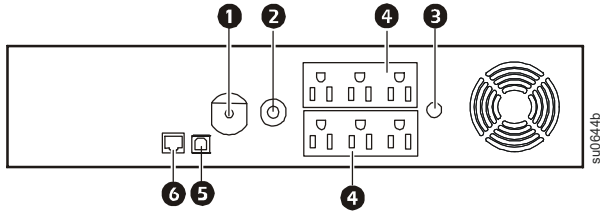

1500 VA 230 Vac

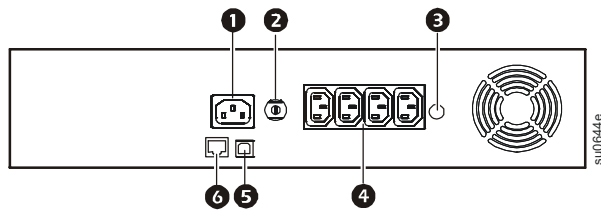

2000 VA 230 Vac

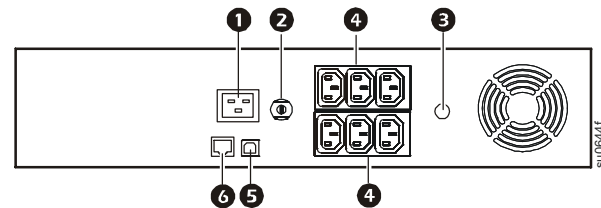

3000 VA 230 Vac

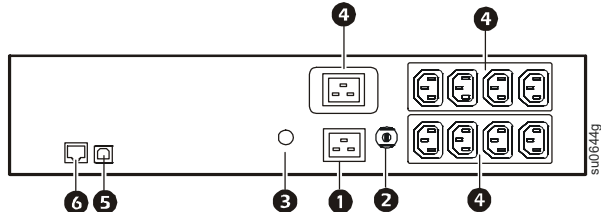

- ❶ UPS input
- ❷ Circuit breaker/Overload protection
- ❸ Chassis ground screw
- ❹ Outlets
- ❺ USB port
- ❻ Serial data port

## Installation

For UPS installation information, refer to the Installation Guide for the Smart-UPS C 1000/1500/2000/3000 VA Rack-Mount 2U included with the UPS.

The Installation Guide is also available on the Documentation CD included with the UPS and on the APC by Schneider Electric web site, [www.apc.com](http://www.apc.com).

# Operation

## ⚠ CAUTION

### RISK OF ELECTRIC SHOCK

- Adhere to all local and national electrical codes.
- Wiring must be performed by qualified electrician.
- Always connect the UPS to a grounded outlet.



**Failure to follow these instructions can result in minor or moderate injury**

**Note:** The UPS will charge to 90% capacity in the first three hours of normal operation.  
**Do not expect full battery runtime capability during this initial charge period.**

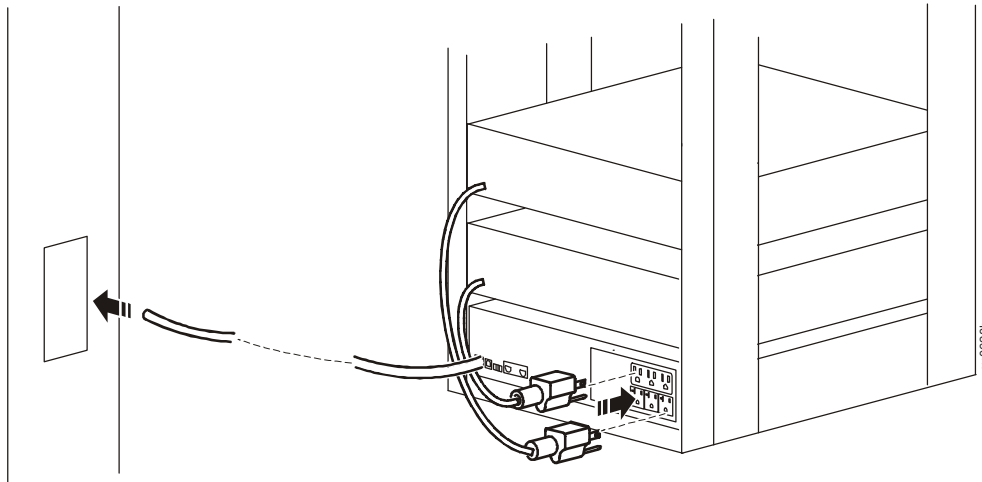
1. Connect equipment to the UPS.
2. Connect the UPS to a two pole, three wire, grounded source.



## Connect equipment to the UPS



	<b>USB port:</b> Connect to a computer to use power management software.
	<b>Serial port:</b> Connect a serial port cable (not supplied) to use power management software.
	<b>Chassis ground screw:</b> Connect the ground leads on transient voltage devices to the chassis ground screw(s), located on the rear panel of the UPS.

## Sensitivity adjustment settings

The UPS detects and reacts to line voltage distortions by transferring to battery backup power to help protect connected equipment. In situations where the connected equipment is too sensitive for the input voltage level it is necessary to adjust the transfer voltage.

1. Connect the UPS to a AC power source. Be sure the UPS is turned off.
2. Place the unit in Configuration Mode, as described in page 11.
3. Use the Sensitivity Setting option to set the transfer voltage range.

When the UPS is in **Configuration Mode**, the **Sensitivity** bar graph icons display the sensitivity level setting. Refer to the examples here as a reference.

		
<b>Low sensitivity</b>	<b>Medium sensitivity</b>	<b>High sensitivity (Default)</b>
<b>120 Vac: 97-136 Vac</b>	<b>120 Vac: 103-130 Vac</b>	<b>120 Vac: 106-127 Vac</b>
<b>230 Vac: 195-265 Vac</b>	<b>230 Vac: 203-257 Vac</b>	<b>230 Vac: 207-253 Vac</b>
Use this setting with equipment that is less sensitive to fluctuations in voltage or waveform distortions.	Use this setting under normal operating conditions.	Use this setting when connected equipment is sensitive to any minor fluctuations in voltage or waveform distortions.

## Status Indicators

### Display panel features

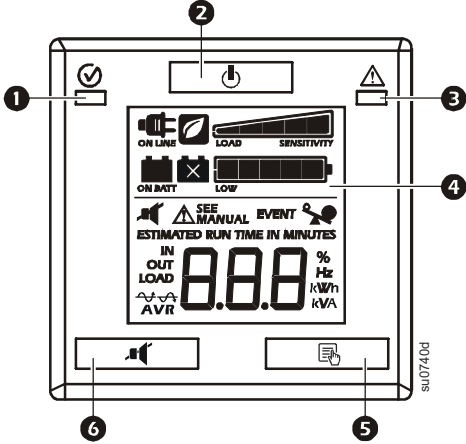
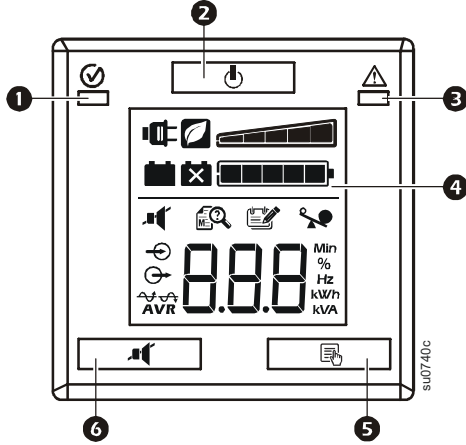





120 Vac	230 Vac
	
<b>1</b> On Line/On Battery LED	<b>4</b> Display interface
<b>2</b> POWER ON/OFF button	<b>5</b> DISPLAY button
<b>3</b> Site Wiring Fault/System Alert LED	<b>6</b> MUTE button

**Note: Refer to “Feature Reference Guide” on page 11 in this manual for a detailed description of the front panel buttons and icons.**



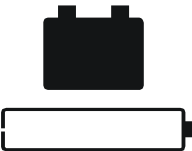













## LED status indicators

Status	LED	Audible Indicator On	Audible Indicator Terminates
<b>Power On</b> The UPS is supplying AC power to connected equipment.	The <b>On Line/On Battery LED</b> illuminates green.	None	N/A
<b>On Battery</b> The UPS is supplying battery power from the internal battery.	The <b>On Line/On Battery LED</b> illuminates amber.	The UPS beeps 4 times every 30 seconds.	The beeping stops when AC power is restored or the MUTE button is pressed for two seconds.
<b>System Alert</b> The UPS has detected an internal error.	<b>System Alert LED</b> illuminates red.	Constant tone	The audible/visible alarm stops when the POWER ON/OFF button is pressed for two seconds. This creates a <b>Reset</b> .
<b>Site Wiring Fault</b> A building wiring fault has occurred. Do not operate the UPS. Contact a qualified electrician to correct the building wiring fault.	<b>Site Wiring Fault LED</b> flashes red.	None	N/A



## LCD status indicators

Status	LCD Icon	Audible Alarms	Audible Alarm Terminates
<b>On Battery</b> The UPS is supplying battery power to the connected equipment.		Beeps 4 times every 30 seconds.	The beeping stops when AC power is restored or the UPS is turned off.
<b>AC Power Overload</b> An overload condition has occurred while the UPS is operating on AC power.		Constant tone	The audible alarm stops when nonessential equipment is disconnected from the outlets or the UPS is turned off
<b>Battery Power Overload</b> An overload condition has occurred while the UPS is operating on battery power.		Constant tone	The audible alarm stops when nonessential equipment is disconnected from the outlets or the UPS is turned off.
<b>Low Battery</b> The UPS is supplying battery power to the connected equipment and the battery is near a total discharge state.		Continuous beeping	The beeping stops when AC power is restored or the UPS is turned off.
<b>Battery Alert</b> The UPS is operating on AC power. The battery does not provide expected backup.		The UPS will beep twice to indicate the battery is disconnected. The UPS will beep continuously for one minute every five hours to indicate that the battery should be replaced.	Verify that the battery is securely connected. The battery is nearing the end of its service life and should be replaced.
<b>System Alert</b> The UPS has detected an internal error.	<b>120 Vac models</b>  <b>230 Vac models</b> 	N/A	Identify the alert message on the display and refer to <b>System Alerts</b> in this manual.

## Display icons

120 Vac	230 Vac	Description
 ON LINE		<b>On Line:</b> The UPS is supplying conditioned AC power to connected equipment.
		<b>Green mode:</b> The UPS is operating at the most efficient level, bypassing unused AVR components while acceptable AC voltage is present. The UPS will enter and exit <b>Green</b> mode automatically and will not compromise power protection.
		<b>Load Capacity:</b> The load capacity percentage is indicated by the number of load bar sections illuminated. Each bar represents 20% of the load capacity.
ESTIMATED RUN TIME IN MINUTES	Min	<b>Estimated Run Time / Min:</b> This indicates the battery runtime minutes that remain if the UPS switches to battery power.
		<b>Battery Charge:</b> The battery charge level is indicated by the number of load bar sections illuminated. When all five blocks are illuminated, the battery is fully charged. Each bar represents 20% of the battery charge capacity.
		<b>Overload:</b> The equipment connected to the UPS is drawing more power than the voltage rating allows.
EVENT		<b>Event:</b> The event counter indicates the number of events that occurred to cause the UPS to switch to battery operation.
		<p><b>Automatic Voltage Regulation (AVR):</b> The UPS has an AVR boost and trim feature that automatically regulates high or low levels of input voltage without using battery power. The UPS also features AVR Bypass which temporarily deactivates the AVR circuitry when the input voltage is within normal range. This conserves battery power and helps to maximize battery life.</p> <p> When illuminated, the UPS is compensating for low input voltage.</p> <p> When illuminated, the UPS is compensating for high input voltage.</p>
IN OUT		<b>In:</b> Input voltage. <b>Out:</b> Output voltage.
		<b>System Alert:</b> The UPS has detected an internal fault. The alert number will illuminate on the display. Refer to “Display icons” on page 10.
		<b>Mute:</b> An illuminated line through the icon indicates that audible alarms are disabled.
		<b>Battery Alert:</b> The icon will flash to indicate that the battery is disconnected. When the icon remains continuously illuminated the UPS has not passed a Self-Test or the battery is near the end of its service life and should be replaced. Refer to “LCD status indicators” on page 9.
		<b>On Battery:</b> The UPS is supplying battery backup power to the connected equipment.





## System Alerts

<b>120 Vac</b> 	<b>230 Vac</b> 	<b>P00</b>	Output Overload
		<b>P01</b>	Output Short Circuit
		<b>P02</b>	Output Over Voltage
		<b>P04</b>	Unit Over Temperature
		<b>P06</b>	AVR Relay Alert
		<b>P13</b>	Inverter Alert



For more information on System Alerts, contact customer support at the APC by Schneider Electric web site, [www.apc.com/support](http://www.apc.com/support).

# Feature Reference Guide

## Normal Mode





Function	Button	Timing (seconds)	UPS State	Description
<b>Power</b>				
<b>Power On</b>		0.2	<b>Off</b>	Press the POWER ON/OFF button to turn on the UPS. The UPS will operate on AC power. If AC power is not available the UPS will operate on battery power.
<b>Power Off</b>		2	<b>On</b>	Press the POWER ON/OFF button to turn off the UPS.
<b>Display</b>				
<b>Status Inquiry</b>		0.2	<b>On</b>	Press to verify the status or condition of the UPS. The LCD will illuminate for 60 seconds.
<b>Mute</b>				
<b>Enable/Disable</b>		2	<b>On</b>	Enable or disable the audible alarms. The <b>Mute</b> icon will illuminate and the UPS will beep once.
<b>Reset</b>		2	<b>Alert</b>	After an alert has been identified, press the POWER ON/OFF button to remove the visual indication and return to standby status.

## Configuration Mode

The Configuration Mode provides additional options for the UPS. Press and hold the MUTE  and DISPLAY  buttons for 2 seconds until the system emits a short beep and the display will flash to indicate the UPS has entered Configuration Mode.

When in Configuration Mode the DISPLAY button forwards the display through the available options and the MUTE button toggles the configuration settings for that option.

**Note:** When system detects 15 seconds of no activity in Configuration Mode, or when you press and hold the MUTE and DISPLAY buttons for 2 seconds until the system emits a short beep, the program automatically exits and returns to Normal mode.

Function	Options	Description
<b>Self-Test</b>	<ul style="list-style-type: none"> <li>• 0: Default Setting</li> <li>• 1: Begin Self-Test</li> </ul>	<p>When set to 1, pressing the DISPLAY button will trigger the self test and exit the Configuration Mode.</p> <p>0 is the default setting and will not initiate a self test, by pressing the DISPLAY button you will advance to the next configuration item.</p> <p><b>Note:</b> When the UPS is in Configuration mode and the UPS output power is off, a Self-Test cannot be initiated.</p>
<b>Sensitivity Setting</b>	<ul style="list-style-type: none"> <li>• High </li> <li>• Medium </li> <li>• Low </li> </ul>	<p>Select the Sensitivity range depending on the desired quality of input AC power:</p> <ul style="list-style-type: none"> <li>• If High is selected, the unit will go on battery power more often to provide the cleanest power supply to the connected equipment.</li> <li>• If Medium is selected, the UPS is under normal operating conditions.</li> <li>• If Low is selected, the UPS will tolerate more fluctuations in power and will go on battery power less often.</li> </ul> <p>If unsure of the local power quality, select Low.</p>
<b>Output Voltage Setting</b> <small>* 230V models only</small>	<ul style="list-style-type: none"> <li>• 220 Vac</li> <li>• 230 Vac</li> <li>• 240 Vac</li> </ul>	<p>Select the appropriate voltage of outlets when the UPS is in Standby mode.</p>
<b>LCD Display Dimmer</b>	<ul style="list-style-type: none"> <li>• Load Bar Icon shows 100% = Always On. </li> <li>• Load Bar Icon shows 0% = Auto Dim. </li> </ul>	<p>When the LCD Display Dimmer is configured to Auto Dim the LCD will illuminate if a button is pressed or an event occurs, then will automatically dim after 60 seconds of no activity.</p>
<b>Green Mode Enable</b>	<ul style="list-style-type: none"> <li>• 0: Disable</li> <li>• 1: Enable</li> </ul>	<p>When Green Mode is enabled the UPS is operating at the most efficient level by bypassing unused AVR components while acceptable AC voltage is present. The UPS will enter and exit Green mode automatically while Enabled.</p>
<b>Clear Event Counter</b>	<ul style="list-style-type: none"> <li>• NA</li> </ul>	<p>Pressing the MUTE button will clear the event counter.</p>

# Troubleshooting

Problem and Possible Cause	Solution
<b>The UPS will not turn on or there is no output</b>	
The UPS has not been turned on.	Press the ON button once to turn on the UPS.
The UPS is not connected to AC power.	Be sure the power cable is securely connected to the UPS and to the AC power supply.
The input circuit breaker has tripped.	Disconnect nonessential equipment and reset the circuit breaker.
The UPS shows very low or no AC input voltage.	Check the AC power supply to the UPS by plugging in a table lamp. If the light is very dim, check the AC voltage.
The battery is not securely connected.	Be sure that all battery connections are secure.
The UPS has detected an internal fault.	Do not attempt to use the UPS. Unplug the UPS and have it serviced immediately.
<b>The UPS is operating on battery while connected to AC power</b>	
The input circuit breaker has tripped.	Disconnect nonessential equipment and reset the circuit breaker.
There is very high, very low, or distorted input line voltage.	Move the UPS to a different outlet on a different circuit. Test the input voltage with the AC voltage display. If acceptable to the connected equipment, reduce the UPS sensitivity.
<b>The UPS is beeping</b>	
The UPS is operating normally.	None. The UPS is helping protect the connected equipment.
<b>The UPS does not provide expected battery backup time</b>	
The UPS battery is weak due to a recent power outage or is near the end of its service life.	Charge the battery. Batteries require recharging after an extended outage. Elevated ambient temperatures, poor quality AC power, and frequent short duration discharges will shorten battery life. If the battery is near the end of its service life, consider replacing the battery even if the replace battery icon is not illuminated.
The UPS is experiencing an overload condition.	Check the UPS load display. Unplug nonessential equipment, such as printers.
<b>The Alert LED is illuminated, the UPS displays an alert message and emits a constant beeping</b>	
The UPS has detected an internal fault.	Do not attempt to use the UPS. Turn the UPS off and have it serviced immediately. If more than one alert is present the alert messages will be displayed alternately on display screen.
<b>The Replace Battery icon is illuminated</b>	
The battery has a weak charge.	Allow the battery to recharge for at least four hours. Then, perform a Self-Test. If the problem persists after recharging, replace the battery.
The replacement battery is not properly connected.	Be sure the battery connector is securely connected.
<b>Site Wiring Fault LED is flashing</b>	
Wiring faults detected include missing ground, line-neutral polarity reversal, and overloaded neutral circuit.	If the UPS indicates a site wiring fault, have a qualified electrician inspect the building wiring. Applicable for 120 Vac units only.

# Battery Replacement

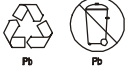

**Always recycle used batteries.**

**For information on recycling a used battery, refer to the Battery Disposal Information sheet included with the replacement battery.**

Battery life is highly dependent on temperature and use. To identify when to replace batteries, Smart-UPS have a predictive battery replacement date indicator in the “About” menu and automatic (and configurable) self-tests.

Proactively replace batteries to maintain the highest availability. To ensure protection and high performance, use only genuine APC replacement battery cartridges (RBC™). The APC RBC contains instructions for battery replacement and disposal. To order a replacement battery go to the APC by Schneider Electric Web site, [www.apc.com](http://www.apc.com).

UPS Model	Replacement Battery
SMC1000-2U	APCRBC124
SMC1000I-2U	
SMC1000I-2URS	
SMC1500-2U	APCRBC132
SMC1500I-2U	
SMC2000I-2U	APCRBC133
SMC2000I-2URS	
SMC3000RMI2U	APCRBC151
SMC3000RMI2URS	

# Transport

---

1. Shut down and disconnect all connected equipment.
2. Disconnect the unit from utility power.
3. Disconnect all internal and external batteries (if applicable).
4. Follow the shipping instructions outlined in the *Service* section of this manual.

# Service

---

If the unit requires service, do not return it to the dealer. Follow these steps:

1. Review the *Troubleshooting* section of the manual to eliminate common problems.
2. If the problem persists, contact APC by Schneider Electric Customer Support through the APC web site, **www.apc.com**.
  - a. Note the model number and serial number and the date of purchase. The model and serial numbers are located on the rear panel of the unit and are available through the LCD display on select models.
  - b. Call APC Customer Support and a technician will attempt to solve the problem over the phone. If this is not possible, the technician will issue a Returned Material Authorization Number (RMA#).
  - c. If the unit is under warranty, the repairs are free.
  - d. Service procedures and returns may vary internationally. Refer to the APC web site for country specific instructions.
3. Pack the unit properly to avoid damage in transit. Never use foam beads for packaging. Damage sustained in transit is not covered under warranty.
  - a. **Note: When shipping within the United States, or to the United States always DISCONNECT ONE UPS BATTERY before shipping in compliance with U.S. Department of Transportation (DOT) and IATA regulations.** The internal batteries may remain in the UPS.
  - b. Batteries may remain connected in the XBP during shipment. Not all units utilize XLBPs.
4. Write the RMA# provided by Customer Support on the outside of the package.
5. Return the unit by insured, prepaid carrier to the address provided by Customer Support.

# Two Year Limited Factory Warranty

Schneider Electric IT Corporation (SEIT), warrants its products to be free from defects in materials and workmanship for a period of two (2) years from the date of purchase. The SEIT obligation under this warranty is limited to repairing or replacing, at its own sole option, any such defective products. Repair or replacement of a defective product or parts thereof does not extend the original warranty period.

This warranty applies only to the original purchaser who must have properly registered the product within 10 days of purchase. Products may be registered online at [warranty.apc.com](http://warranty.apc.com).

SEIT shall not be liable under the warranty if its testing and examination disclose that the alleged defect in the product does not exist or was caused by end user or any third person's misuse, negligence, improper installation, testing, operation or use of the product contrary to SEIT recommendations or specifications. Further, SEIT shall not be liable for defects resulting from: 1) unauthorized attempts to repair or modify the product, 2) incorrect or inadequate electrical voltage or connection, 3) inappropriate on site operation conditions, 4) Acts of God, 5) exposure to the elements, or 6) theft. In no event shall SEIT have any liability under this warranty for any product where the serial number has been altered, defaced, or removed.

**EXCEPT AS SET FORTH ABOVE, THERE ARE NO WARRANTIES, EXPRESS OR IMPLIED, BY OPERATION OF LAW OR OTHERWISE, APPLICABLE TO PRODUCTS SOLD, SERVICED OR FURNISHED UNDER THIS AGREEMENT OR IN CONNECTION HEREWITH.**

**SEIT DISCLAIMS ALL IMPLIED WARRANTIES OF MERCHANTABILITY, SATISFACTION AND FITNESS FOR A PARTICULAR PURPOSE.**

**SEIT EXPRESS WARRANTIES WILL NOT BE ENLARGED, DIMINISHED, OR AFFECTED BY AND NO OBLIGATION OR LIABILITY WILL ARISE OUT OF, SEIT RENDERING OF TECHNICAL OR OTHER ADVICE OR SERVICE IN CONNECTION WITH THE PRODUCTS.**

**THE FOREGOING WARRANTIES AND REMEDIES ARE EXCLUSIVE AND IN LIEU OF ALL OTHER WARRANTIES AND REMEDIES. THE WARRANTIES SET FORTH ABOVE CONSTITUTE SEIT'S SOLE LIABILITY AND PURCHASER EXCLUSIVE REMEDY FOR ANY BREACH OF SUCH WARRANTIES. SEIT WARRANTIES EXTEND ONLY TO ORIGINAL PURCHASER AND ARE NOT EXTENDED TO ANY THIRD PARTIES.**

**IN NO EVENT SHALL SEIT, ITS OFFICERS, DIRECTORS, AFFILIATES OR EMPLOYEES BE LIABLE FOR ANY FORM OF INDIRECT, SPECIAL, CONSEQUENTIAL OR PUNITIVE DAMAGES, ARISING OUT OF THE USE, SERVICE OR INSTALLATION OF THE PRODUCTS, WHETHER SUCH DAMAGES ARISE IN CONTRACT OR TORT, IRRESPECTIVE OF FAULT, NEGLIGENCE OR STRICT LIABILITY OR WHETHER SEIT HAS BEEN ADVISED IN ADVANCE OF THE POSSIBILITY OF SUCH DAMAGES. SPECIFICALLY, SEIT IS NOT LIABLE FOR ANY COSTS, SUCH AS LOST PROFITS OR REVENUE, WHETHER DIRECT OR INDIRECT, LOSS OF EQUIPMENT, LOSS OF USE OF EQUIPMENT, LOSS OF SOFTWARE, LOSS OF DATA, COSTS OF SUBSTITUANTS, CLAIMS BY THIRD PARTIES, OR OTHERWISE.**

**NOTHING IN THIS LIMITED WARRANTY SHALL SEEK TO EXCLUDE OR LIMIT SEIT'S LIABILITY FOR DEATH OR PERSONAL INJURY RESULTING FROM ITS NEGLIGENCE OR ITS FRAUDULENT MISREPRESENTATION OF TO THE EXTENT THAT IT CANNOT BE EXCLUDED OR LIMITED BY APPLICABLE LAW.**

To obtain service under warranty you must obtain a Returned Material Authorization (RMA) number from customer support. Customers with warranty claims issues may access the SEIT worldwide customer support network through the SEIT web site: [www.apc.com](http://www.apc.com). Select your country from the country selection drop down menu. Open the Support tab at the top of the web page to obtain information for customer support in your region. Products must be returned with transportation charges prepaid and must be accompanied by a brief description of the problem encountered and proof of date and place of purchase.